

**23<sup>rd</sup> INTERNATIONAL CONFERENCE  
AND SCHOOL  
ON QUANTUM ELECTRONICS**

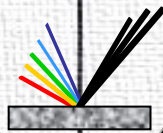

# **LASER PHYSICS AND APPLICATIONS**

## **BOOK OF ABSTRACTS**

**23-27 September 2024,  
Ravda, Bulgaria**

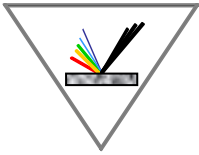

БЪЛГАРСКА АКАДЕМИЯ НА НАУКИТЕ ИНСТИТУТ ПО ЕЛЕКТРОНИКА "АКАДЕМИК ЕМИЛ ДЖАКОВ"

BULGARIAN ACADEMY OF SCIENCES INSTITUTE OF ELECTRONICS "ACADEMICIAN EMIL DJAKOV"

**XXIII INTERNATIONAL CONFERENCE AND  
SCHOOL ON QUANTUM ELECTRONICS  
"LASER PHYSICS AND APPLICATIONS"**

**23-27 September 2024, Ravda, Bulgaria**

**BOOK OF ABSTRACTS**

## **ABOUT THE ACADEMICIAN EMIL DJAKOV INSTITUTE OF ELECTRONICS**

*72 Tsarigradsko Chaussee Blvd., 1784 Sofia, Bulgaria*

<http://www.ie-bas.org/>

The Institute of Electronics at the Bulgarian Academy of Sciences was established in 1963 as a non-profit state organization conducting research, education and dissemination of scientific knowledge in the fields of Physical Electronics, Photonics and Quantum Electronics and Radio Sciences.

The research efforts in physical electronics are concentrated on studying and solving the problems of generating and controlling electron and ion beams and their interaction with materials. This includes theoretical modeling, modern techniques, research and industrial equipment for micro- and nano-structuring, thin films deposition and study, modification of surfaces, vacuum melting and welding of metals by intense electron beams. The physical basis is being formed of creating nanostructures, nanomaterials and nanoelements by using electron and ion beams. Furthermore, fundamental properties are being investigated of gasses and gas plasma, plasma arcs and plasma torches in view of developing diagnostic techniques and applications in thin films deposition and plasma chemistry.

The research in photonics and quantum electronics comprises theoretical and experimental studies on the interaction of short and ultrashort laser pulses with matter; development of novel nanostructuring technologies; laser thin-films deposition and treatment; light-induced absorption and transmission in alkaline vapors; development of complex laser systems for analysis and modification of semiconducting and superconducting materials; theoretical and experimental investigation of non-linear optical phenomena; biomedical photonics.

The research efforts in radiophysics are directed to clarifying the processes of interaction of optical and microwave electromagnetic radiation with the atmosphere and the Earth's surface; developing experimental systems for laser remote sensing and monitoring of the atmosphere; microwave remote radiometric measurement of soil moisture content; developing algorithms and techniques for signals and information processing; constructing microwave units and systems for radar and communication applications; studying non-linear processes in optical communication media. New ferrite devices with micrometric dimensions were developed with possibility for a higher degree of integration. Active research on gyro-magnetic materials is underway, in view of reaching higher frequency ranges, especially mm-waves for wireless communications and protection from powerful microwave radiation.

The Academician Emil Djakov Institute of Electronics was where the first Bulgarian laser, lidar, plasma torch, ultrahigh vacuum pump, micro-channel electron-optical converter, parametric microwave amplifier, Josephson junctions and SQUID, portable microwave moisture meter, magnetometer, installations for electron lithography, electron beam melting, refining, and welding were built, followed by the development of several advanced e-beam technologies, novel types of optical gas sensors, pioneering achievements in nanostructuring and nanoparticle formation, laser and plasma high technologies.

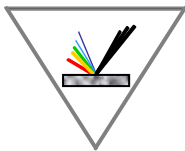

XXIII International Conference and School on Quantum Electronics:  
“Laser Physics and Applications”

XXIII INTERNATIONAL CONFERENCE AND SCHOOL ON  
QUANTUM ELECTRONICS  
“LASER PHYSICS AND APPLICATIONS”

ORGANIZED BY

The Institute of Electronics, Bulgarian Academy of Sciences

*In cooperation with*



*Bulgarian Academy of Sciences*  
<http://www.bas.bg/>



*Bulgarian National Science Fund*<sup>†</sup>  
<https://bnsf.bg/>

Project No. КП-06-МНФ/3, 23.05.2024



<https://upb.phys.uni-sofia.bg/>



<https://www.aquachim.bg/>



<https://valerus-bg.com/>



<https://www.optica.org/>



<https://astelbg.com/>

---

<sup>†</sup>Disclaimer: The National Science Fund may not be held liable for the content of the reports and published materials of the scientific forum.

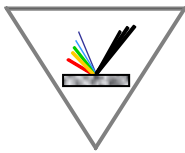

## COMMITTEES

---

### INTERNATIONAL ADVISORY COMMITTEE

NAME	AFFILIATION	COUNTRY
	<b>CHAIRMAN:</b>	
Prof. Alexandros Serafetinides	National Technical University of Athens (NTUA), Applied Physics Department	GREECE
	<b>MEMBERS:</b>	
Prof. Adolfo Comeron	CommSensLab, Dept of Signal Theory and Communications, Universitat Politècnica de Catalunya, Barcelona	SPAIN
Prof. Mitsuhiro Terakawa	School of Integrated Design Engineering, Keio University, Hiyoshi, Kohoku-ku, Yokohama, Kanagawa	JAPAN
Prof. Pradip N. Ghosh	University of Burdwan, Department of Physics, Bardhaman	INDIA
Prof. David Sarkisyan	Institute for Physical Research, National Academy of Sciences of Armenia	ARMENIA
Prof. Razvigor Ossikovski	Ecole Polytechnique, Institut Polytechnique de Paris, Palaiseau	FRANCE
Prof. Dr. Sc. Vladimir N. Serkin	Benemerita Universidad Autonoma de Puebla, Instituto de Ciencias, Puebla	MEXICO
Dr. Heidi Declercq	Tissue Engineering Lab, Department of Development and Regeneration, Faculty of Medicine, KU Leuven Campus Kulak, Kortrijk	BELGIUM
Dr. Lyubomir Lazov	Rezekne Academy of Technology, Latvia	LATVIA
Dr. Katarzyna Grochowska	The Szewalski Institute of Fluid-Flow Machinery, Polish Academy of Sciences, Gdansk	POLAND
Dr. Ravendran Ratheesh	Centre for Materials for Electronics Technology, Ministry of Electronics and Information Technology, Government of India, Hyderabad	INDIA

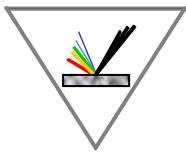

**XXIII International Conference and School on Quantum Electronics:  
“Laser Physics and Applications”**

Dr. Kiriaki Chrissopoulou      Institute of Electronic Structure and Laser,  
Foundation for Research and Technology-      GREECE  
Hellas

**PROGRAM COMMITTEE**

<b>NAME</b>	<b>AFFILIATION</b>	<b>COUNTRY</b>
Prof. Nikolay Nedyalkov	Institute of Electronics, Bulgarian Academy of Sciences	BULGARIA
Assoc. Prof. Sanka Gateva	Institute of Electronics, Bulgarian Academy of Sciences	BULGARIA
Assoc. Prof. Tanja Dreischuh	Institute of Electronics, Bulgarian Academy of Sciences	BULGARIA
Dr. Tsanislava Genova	Institute of Electronics, Bulgarian Academy of Sciences	BULGARIA
Assoc. Prof. Albena Daskalova	Institute of Electronics, Bulgarian Academy of Sciences	BULGARIA
Prof. Katia Vutova	Institute of Electronics, Bulgarian Academy of Sciences	BULGARIA

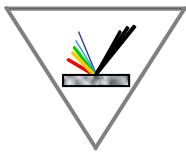

**XXIII International Conference and School on Quantum Electronics:  
“Laser Physics and Applications”**

**LOCAL ORGANIZING COMMITTEE**

**CHAIR:** Assoc. Prof. Dr. Christina Andreeva

**VICE-CHAIR:** Dr. Tsanislava Genova

**SECRETARY:** Dr. Aleksandra Zhelyazkova

**MEMBERS:**

Assoc. Prof. Dr. Nadya Stankova

Assoc. Prof. Dr. Petko Todorov

Assoc. Prof. Dr. Mihaela Koleva

Dr. Maria Ormanova

Dr. Stoyan Tsvetkov

Dr. Ivan Grigorov

Chavdar Ghelev

Borislava Georgieva

**ADDRESS FOR COMMUNICATION**

Institute of Electronics  
Bulgarian Academy of Sciences  
72 Tsarigradsko Chaussee Blvd.  
1784 Sofia, Bulgaria

<https://icsqe2024.ie-bas.org>

**tel./fax:** (+359 2) 974 5742

**e-mail:** [icsqe2024@gmail.com](mailto:icsqe2024@gmail.com)

**TOPICS:**

- A.** Laser - matter interactions
- B.** Laser spectroscopy and metrology
- C.** Laser remote sensing and ecology
- D.** Lasers in biology and medicine
- E.** Laser systems and nonlinear optics
- F.** Alternative techniques for material synthesis and processing

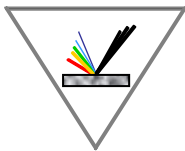

---

## TABLE OF CONTENTS

---

### INVITED LECTURES

---

---

#### LASER - MATTER INTERACTIONS

**IL.A1 LASER ADDITIVE MANUFACTURING: EXPERIMENTAL RESULTS VERSUS THEORETICAL MODELLING,**

*Ion N. Mihailescu, Muhammad Arif Mahmood, Cristian N. Mihailescu, Mihai Oane, Carmen Ristoscu, Sinziana Andreea Anghel, Andrei C. Popescu, Diana Chioibas* ..... 19

**IL.A2 LASER-TITANIA INTERACTIONS: TOWARDS MANIPULATION OF MORPHOLOGY, STRUCTURE AND ELECTROCHEMICAL PROPERTIES,**

*Katarzyna Grochowska* ..... 20

**IL.A3 TOWARDS UNDERSTANDING GAS-PHASE CHEMISTRY DURING PULSED LASER DEPOSITION BY MEANS OF REAL-TIME PLASMA DIAGNOSTIC,**

*Stefan A. Irimiciuc, Jan Lančok*..... 21

**IL.A4 DEPOSITION OF FUNCTIONAL MULTI-LAYERED COATINGS BY PULSED PLASMA TECHNIQUES (PLD AND PED),**

*R. I. Tomov, J. Robinson* ..... 22

#### LASER SPECTROSCOPY AND METROLOGY

**IL.B1 ATOM-SURFACE INTERACTION TURNED INTO A DIAGNOSTICS OF SPECTRALLY SHARP NEAR-FIELD THERMAL EMISSION BY A SURFACE POLARITON – COMPARISON WITH PREDICTIONS OF FAR-FIELD EMISSIVITY AND WITH ELLIPSOMETRY,**

*J.C. de Aquino Carvalho, I. Maurin, P. Chaves de Souza Segundo, A. Laliotis, D. de Sousa Meneses, S. Hurand, T. Martinez, O. Rozenbaum, D. Bloch* ..... 23

**IL.B2 MULTIPLE ELECTRON DYNAMICS OF ATOMS IN STRONG FEMTOSECOND LASER FIELDS,**

*Dmitry Efimov* ..... 25

#### LASER REMOTE SENSING AND ECOLOGY

**IL.C1 THE ROLE OF THE EUROPEAN AEROSOL LIDAR NETWORK (EARLINET) IN THE AEROSOL, CLOUDS AND TRACE GASES RESEARCH INFRASTRUCTURE (ACTRIS),**

*Adolfo Comerón, Constantino Muñoz-Porcar, Alejandro Rodríguez-Gómez* ..... 26

**IL.C2 MEASURING THE ATMOSPHERE USING RAMAN SCATTERING LIDAR,**

*Geraint Vaughan* ..... 27



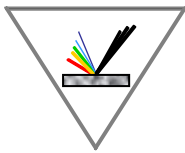

**IL.C3 LIDAR INNOVATIONS FOR TECHNOLOGIES AND ENVIRONMENTAL SCIENCES (LITES): A FACILITY FOR SPECTROSCOPIC IN-SITU AND REMOTE SENSING ATMOSPHERIC STUDIES,**  
*B. Tatarov and D. Müller*..... 27

### **LASERS IN BIOLOGY AND MEDICINE**

**IL.D1 LASER-INDUCED BREAKDOWN SPECTROSCOPY FOR DIRECT DETERMINATION OF HEAVY METALS IN OILS,**  
*Milica Vinić* ..... 29

**IL.D2 NONLINEAR IMAGING AND LASER NANO-SURGERY OF FUNGAL CELLS TO ENABLE ELECTROPHYSIOLOGICAL MEASUREMENTS,**  
*Tanja Pajić, Katarina Stevanović, Nataša Todorović, Steva Lević, Svetlana Savić Šević, Dejan Pantelić, Miroslav Živić, Mihailo Rabasović and Aleksandar Krmpot* ..... 30

**IL.D3 NANOARCHAEOSOMES COUPLED GOLD NANORODS: A SYNERGISTIC APPROACH TO CHEMO-PHOTOTHERMAL CANCER THERAPY,**  
*Shaik Sameer Basha, Poornima Budime Santhosh, Lyubomir Stoychev, Julia Genova, Swathi Sudhakar* ..... 31

**IL.D4 OPTICAL DIAGNOSIS OF TISSUE WITH IMAGING MUELLER POLARIMETRY,**  
*Tatiana Novikova* ..... 32

### **LASER SYSTEMS AND NONLINEAR OPTICS**

**IL.E1 THE CHALLENGES OF THE APPLICATIONS OF PW LASER-PLASMAS,**  
*J.C. Kieffer*..... 34

### **ALTERNATIVE TECHNIQUES FOR MATERIAL SYNTHESIS AND PROCESSING**

**IL.F1 CHARGED-PARTICLE-BEAM LITHOGRAPHY,**  
*Ivan Kostic, Katia Vutova* ..... 35

**IL.F2 ADDITIVE MANUFACTURING OF BIOCERAMICS: STATE OF THE ART AND BEYOND,**  
*Nicolas Somers* ..... 36

**IL.F3 FABRICATION, CHARACTERIZATION AND APPLICATION OF 1D SEMICONDUCTOR NANOMATERIALS,**  
*Muhammad Bilal Khan, Ahmad Echresh, Sayantan Ghosh, Phanish Chava, Muhammad Moazzam Khan, Oliver Steuer, Slawomir Prucnal, René Hübner, Lars Rebohle, Shengqiang Zhou, Manfred Helm, Artur Erbe, Yordan M. Georgiev* ..... 37

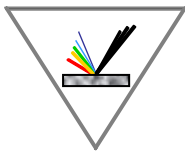

**IL.F4 THE SUM OF ALL FEARS: PHYSICAL CHALLENGES IN THE RETICLE DEFECTIVITY OF THE ASML HIGH-NA EUV LITHOGRAPHY SYSTEMS,**  
*Georgi Nenchev* ..... 38

**ORAL PRESENTATIONS – Session I**

---

---

**OP.F1 NEAR-INFRARED PHOTODETECTORS BASED ON SINGLE GERMANIUM NANOWIRES,**

*Ahmad Echresh, Mohd Saif Shaikh, Mircea Traian Catuneanu, Artur Erbe, Lars Rebohle, Kambiz Jamshidi, Yonder Berencén, Yordan M. Georgiev*..... 40

**OP.A1 IN-SITU ANALYSIS BY STOKES POLARIMETRY AT THE RECORDING BEAM WAVELENGTH OF THE POLARIZATION PROPERTIES OF POLARIZATION HOLOGRAPHIC GRATINGS WITH AND WITHOUT SURFACE RELIEF,**

*L. Nedelchev, G. Mateev, L. Nikolova, E. Stoykova, D. Nazarova*..... 42

**OP.D1 TUNABLE PARAMETRIC LIGHT SOURCES FOR APPLICATIONS IN BIOPHYSICS AND MEDICINE,**

*Lyubomir Stoychev, Dragomir Vasilev, Alexander Parvanov, Stephan Shishkov, Todor Petrov, Ivan Buchvarov* ..... 42

**OP.C1 LASER SYSTEM FOR REMOTE 3D REGISTRATION AND MEASUREMENT OF VIBRATION AND TRANSLATIONAL MOVEMENT OF OBJECTS,**  
*Margarita Angelova Deneva, Marin Nenchev Nenchev* ..... 43

**OP.F2 PRELIMINARY STUDY OF THE REACTIVITY OF A PRIMAL CARBON CLUSTER TOWARDS AMMONIA IN SPACE,**

*D. A. Kalchevski, D. V. Trifonov, S. K. Kolev, V. N. Popov, H. A. Aleksandrov and T. I. Milenov* ..... 45

**OP.F3 INITIAL RESULTS ON THE MECHANISM OF CARBONIZATION OF {001} Si-SUBSTRATE AT HIGH TEMPERATURE,**

*Stefan K. Kolev, Dobromir A. Kalchevski, Dimitar V. Trifonov, Hristiyan A. Aleksandrov, Teodor I. Milenov* ..... 46

**ORAL PRESENTATIONS – Session II**

---

---

**OP.E1 NEW LASER METHOD FOR INITIATING NUCLEAR REACTIONS IN THE DECAY OF HELIUM NUCLEI TO NUCLEI OF HELIUM ISOTOPES,**

*E. Iordanova, G. Yankov, I. P. Angelov, L. M. Kovachev*..... 47

**OP.E2 IMPACT OF IMPERFECT SURFACE OF COMPRESSOR DIFFRACTION GRATINGS ON THE FOCAL INTENSITY OF A FEMTOSECOND LASER PULSE,**

*Efim Khazanov* ..... 48

---

---

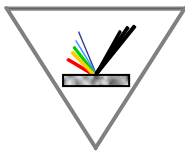

**ORAL PRESENTATIONS – Session III**

---

---

- OP.F4 2D MoS<sub>2</sub> SYNTHESIS PROCESS ENHANCEMENT USING MIXED PRECURSORS,**  
*Blagovest Napoleonov, Vladimira Videva, Nikolay Minev, Dimitre Dimitrov, Vera Marinova*  
..... 50
- OP.B1 DFT SIMULATION OF BILAYER GRAPHENE RAMAN SPECTRUM,**  
*Dimitar V. Trifonov, Dobromir A. Kalchevski, Stefan K. Kolev, Valentin N. Popov, Hristiyan A. Aleksandrov and Teodor I. Milenov* ..... 51

**ORAL PRESENTATIONS – Session IV**

---

---

- OP.E3 COMPARISON OF PRISM COMPENSATED FS PULSE PARAMETERS USING SPIDER, GRENOUILLE AND INTERFEROMETRIC AUTOCORRELATION,**  
*M. Zhekova, N. Dimitrov, N. Kazlachev, A. Dreischuh*..... 52
- OP.E4 NECKLACE TO SECOND-HARMONIC QUASI-NON-DIFFRACTING BEAM CONVERSION,**  
*N. Dimitrov, K. Christov, M. Zhekova, A. Dreischuh* ..... 53
- OP.B2 EXPERIMENTAL INVESTIGATION OF CESIUM D2 LINE MAGNETO-OPTICAL RESONANCES IN 1-D CONFINED ATOMIC VAPOR WITH MICROMETRIC THICKNESS,**  
*P. Todorov, N. Petrov, E. Taskova*..... 54
- OP.D2 SPECTRAL PROPERTIES OF COLLAGEN MODIFICATIONS AND THEIR APPLICATION FOR DIAGNOSTICS,**  
*Ts. Genova, Al. Zhelyazkova, L. Zaharieva, I. Angelov*..... 55

**POSTER SESSION I**

**A - LASER - MATTER INTERACTIONS**

- P.A1 POLARIZATION GRATINGS RECORDED IN AZOPOLYMER THIN FILMS BY DIGITAL POLARIZATION HOLOGRAPHY,**  
*Nataliya Berberova-Buhova, Lian Nedelchev, Georgi Mateev, Branimir Ivanov, Ludmila Nikolova, Blaga Blagoeva, Elena Stoykova, Dimana Nazarova*..... 57
- P.A2 POLARIZATION HOLOGRAPHIC GRATINGS IN PHOTOANISOTROPIC MATERIALS DOPED WITH METALLIC AND METALLIC COMPLEXES NANOPARTICLES,**  
*D. Nazarova, N. Berberova-Buhova, G. Mateev, A. Stoilova, D. Dimov, E. Stoykova, Keehoon Hong and L. Nedelchev* ..... 58
- P.A3 SUPERFICIAL STRUCTURING OF COPPER BY FEMTOSECOND LASER RADIATION FOR DEVELOPMENT OF ANTIBACTERIAL SURFACES,**  
*Emil Filipov, Liliya Angelova, Ina Erceg, Albena Daskalova* ..... 59

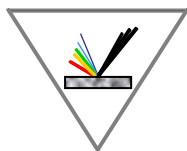

<b>P.A4 TUNING THE SURFACE PROPERTIES OF STAINLESS-STEEL THROUGH SYNERGISTIC EFFECT OF LIPSS AND MAGNETRON SPUTTERING,</b> <i>Albena Daskalova, Liliya Angelova, Harleen Kaur, Angela Ivask, Maja Sikiric, Tihomir Car, Qun Ren, Mihyun Lee, Abeer Shaalan, Lucy di Silvio</i> .....	<b>60</b>
<b>P.A5 PHOTSENSITIVE CHARACTERISTICS OF ZnO AND ZnO-TiO<sub>2</sub> NANOSTRUCTURES PRODUCED BY OPEN-AIR PLD,</b> <i>T. Dilova, A. Og. Dikovska, G. Atanasova, N. N. Nedyalkov</i> .....	<b>61</b>
<b>P.A6 ULTRA-SHORT-LASER-BASED SUSTAINABLE STRUCTURING OF POLYPROPYLENE SURFACES FOR FREQUENTLY TOUCHED SUPERFICIES,</b> <i>Liliya Angelova, Albena Daskalova, Anna Dikovska</i> .....	<b>62</b>
<b>P.A7 LASER STRUCTURING OF THIN METAL FILMS,</b> <i>N. N. Nedyalkov, P. A. Atanasov, A. O. Dikovska, K. Grochowska, J. Karczewski, M. Sawczak, R. Jendrzewski</i> .....	<b>63</b>
<b>P.A8 NANO AND MICRO-STRUCTURING OF METAL-DOPED CaP SURFACE VIA LASER PROCESSING FOR BIOMIMETIC AND ANTIBACTERIAL ORTHOPEDIC IMPLANTS,</b> <i>M. Oliveira, L. Angelova, A. Daskalova</i> .....	<b>64</b>
<b>P.A9 ASSESSMENT OF METHODS FOR DETERMINING THE COLOR PROPERTIES OF LASER-ENGRAVED DENIM FABRIC,</b> <i>B. Stoyanov, I. Banev, D. Kovacheva</i> .....	<b>65</b>
<b>P.A10 PLASMON-ENHANCED PHOTOLUMINESCENCE OF LASER-PRODUCED NOBLE METAL/SEMICONDUCTOR COMPOSITE NANOSTRUCTURES,</b> <i>Mihaela Koleva, Anna Dikovska, Nikolay Nedyalkov, Tsanislava Genova, Georgi Avdeev</i> ..	<b>66</b>
<b>P.A11 SOME INITIAL RESULTS ON MODIFICATION OF aC:H FILMS BY PULSED LASER IRRADIATION,</b> <i>D. Karaivanova, A. Dikovska, K. Kirilov, E. Valcheva and T. Milenov</i> .....	<b>67</b>
<b>P.A12 LASER-ASSISTED SYNTHESIS OF INORGANIC NANOCOMPOSITES FOR INCORPORATION IN POLYMETHYL METHACRYLATE FREESTANDING FILMS,</b> <i>N. Stankova, N. Nedyalkov, A. Dikovska, A. Nikolov, D. Karashanova</i> .....	<b>68</b>
<b>P.A13 SURFACE MODIFICATION OF TITANIUM TARGET BY LASER ABLATION IN ORGANIC SOLUTIONS,</b> <i>Ro. Nikov, Ru. Nikov, N. Nedyalkov, St. Valkov, L. Aleksandrov, M. Sawczak, K. Grochowska, R. Jendrzewski</i> .....	<b>68</b>
<b>P.A14 LANGMUIR–BLODGETT FILMS OF FLUORESCENTLY-LABELED PHOSPHOLIPIDS FOR NANO-BIO-SENSORS CHARACTERIZED BY LASER-INDUCED FLUORESCENCE,</b> <i>George R. Ivanov, Georgi B. Hadjichristov, Yordan G. Marinov</i> .....	<b>69</b>

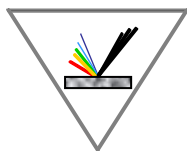

**P.A15 LASER-BEAM OPTO-DIELECTRIC SPECTROSCOPY FOR THE STUDY OF NANOCOMPOSITES FROM 5CB NEMATIC LIQUID CRYSTALS AND POLYMER-COATED GOLD NANOPARTICLES,**

*Georgi B. Hadjichristov, Yordan G. Marinov, George R. Ivanov, Alexander G. Petrov ..... 70*

**B - LASER SPECTROSCOPY AND METROLOGY**

**P.B1 NEW FEATURES OF THE DARK STATE RESONANCES ON THE POTASSIUM D2 LINE IN HANLE CONFIGURATION FOR MAGNETOMETRY APPLICATIONS,**  
*S. Tsvetkov and S. Gateva..... 72*

**P.B2 INFLUENCE OF THE LASER EXCITATION LINEWIDTH ON THE PARAMETERS OF EIA RESONANCES IN <sup>87</sup>Rb,**  
*E. Taskova, N. Petrov, P. Todorov and C. Andreeva..... 73*

**P.B3 EXCITATION-EMISSION MATRICES FLUORESCENCE SPECTROSCOPY FOR ANALYSIS OF BULGARIAN TRADITIONAL WINE VARIETIES,**  
*Lidia Zaharieva, Tsanislava Genova, Yana Medarska-Georgieva, Kamelia Gechovska, Ivan Angelov, Aleksandra Zhelyazkova, Victoria Mircheva, Vera Deneva, Christina Andreeva, Asparuh Markovski, Daniela Nedeltcheva-Antonova, Liudmil Antonov ..... 74*

**C - LASER REMOTE SENSING AND ECOLOGY**

**P.C1 TYPOLOGY AND CLIMATOLOGY OF THE AEROSOL FIELD OVER SOFIA, BULGARIA,**  
*Eleonora Toncheva, Tsvetina Evgenieva, Ljuan Gurdev, Tanja Dreischuh..... 75*

**P.C2 DIAL SOUNDER OF ATMOSPHERIC GREENHOUSE GASES IMPLEMENTING HIGH-POWER BROADBAND LASER DIODES AND SPECTROSCOPIC CORRELATION TECHNIQUE,**  
*Stoyan Penchev, Vasilka Pencheva, Tanja Dreischuh ..... 76*

**P.C3 ANALYSIS OF A WINTERTIME SAHARAN DUST EVENT OVER SOFIA, BULGARIA, USING MULTIPLE SENSORS,**  
*Liliya Vulkova, Zahari Peshev, Tsvetina Evgenieva, Anatoli Chaikovsky, Vladislav Pescherenkov, Stefan Dosev, Atanaska Deleva and Tanja Dreischuh..... 77*

**P.C4 EXTREME HEAT WAVES OVER EUROPE IN JULY 2023: LIDAR AND SUN-PHOTOMETER OBSERVATIONS OF SAHARAN DUST LOADS ABOVE SOFIA, BULGARIA,**  
*Stefan Dosev, Zahari Peshev, Tsvetina Evgenieva, Liliya Vulkova, Ljuan Gurdev, Ivan Grigorov, Luybomir Popov and Tanja Dreischuh ..... 78*

**D - LASERS IN BIOLOGY AND MEDICINE**

**P.D1 A COMPARATIVE STUDY ON FLUORESCENCE AND RAMAN SPECTROSCOPY FOR DISCRIMINATION OF ESSENTIAL OILS,**  
*A. Zhelyazkova and Ts. Genova ..... 79*

**P.D2 CUTTING EDGE TECHNIQUE FOR DETERMINATION OF SPATIAL RESOLUTION LIMITS OF NONLINEAR LASER SCANNING MICROSCOPY,**

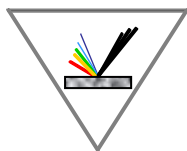

XXIII International Conference and School on Quantum Electronics:  
“Laser Physics and Applications”

*M. Bukumira, J. Jelić, A. Denčevski, M. D. Rabasović, N. Vujičić, A. Senkić, A. Supina, L. Žužić, B. Radatović, T. Pajić, A. Krmpot* ..... 80

**P.D3 IN VIVO INVESTIGATION OF THE EFFECTS OF NAIL ART ON THE NAIL PLATE THROUGH OPTICAL METHODS,**

*V. Mircheva, Ts. Genova, L. Zaharieva, Al. Zhelyazkova, L. Avramov* ..... 81

**P.D4 PHOTODYNAMIC INHIBITION OF PATHOLOGY- ACCOMPANYING ENZYMES: EFFECT OF IRRADIATION SPECTRA,**

*Diana Braikova, Ivan Angelov and Vanya Mantareva* ..... 82

**P.D5 INFLUENCE OF THE SCANNING FREQUENCY ON THE SURFACE TOPOGRAPHY OF ELECTRON-BEAM MODIFIED Ti6Al4V ALLOY,**

*Ivana Ilievska, Maria Ormanova, Borislav Stoyanov, Georgi Kotlarski, Andreana Andreeva, Stefan Valkov* ..... 83

**P.D6 NIR-TRIGGERED SYNERGISTIC PHOTO-CHEMOTHERAPY USING NANOARCHAEOSOMES AND GRAPHENE OXIDE NANOMATERIALS,**

*Renugaa Suresh, Poornima Budime Santhosh, Lyubomir Stoychev, Kamelia Hristova-Panusheva, Natalia Krasteva, Julia Genova, Swathi Sudhakar* ..... 83

**P.D7 MACHINE LEARNING WITH INSUFFICIENT DATA FOR CLASSIFICATION OF FOOD OIL MIXTURES BY MEANS OF LIF SPECTRA,**

*A. Markovski, L. Zaharieva, Ts. Genova and C. Andreeva* ..... 84

## POSTER SESSION II

### E - LASER SYSTEMS AND NONLINEAR OPTICS

**P.E1 GOLD VAPOR LASER OSCILLATING IN VISIBLE AND ULTRAVIOLET SPECTRAL RANGES ON ATOMIC GOLD SELF-TERMINATING TRANSITIONS,**

*I. K. Kostadinov, K. A. Temelkov, S. I. Slaveeva* ..... 86

**P.E2 COPPER VAPOR LASER OSCILLATING IN THE ULTRAVIOLET SPECTRAL RANGE THROUGH SECOND HARMONIC GENERATION,**

*I. K. Kostadinov, K. A. Temelkov, S. I. Slaveeva, L. I. Stoychev* ..... 87

**P.E3 ROGUE WAVE CLUSTERS OF THE EXTENDED NONLINEAR SCHRÖDINGER EQUATIONS,**

*Stanko N. Nikolić and Milivoj R. Belić* ..... 88

**P.E4 INVESTIGATION OF NONLINEAR PROPERTIES OF FIBROIN (SF) USING THE Z-SCAN METHOD,**

*G. Yankov, S. Karatodorov, V. Atanassova, K. S. Shumanov, A. Daskalova, E. Filipov, L. Angelova, E. Iordanova* ..... 89

**P.E5 LINEAR OPTICS OF BROAD-BAND LASER PULSES. DIFFRACTION AND DISPERSION,**

*P. Miteva, D. Dakova, D. Georgieva, E. Iordanova, G. Yankov, K. L. Kovachev and L. M. Kovachev* ..... 89

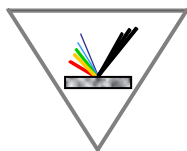

**P.E6 EFFICIENCY OF THE ENERGY EXCHANGE PROCESS DURING FOUR-WAVE MIXING UNDER THE INFLUENCE OF SELF-PHASE MODULATION AND CROSS-PHASE MODULATION,**

*Zara Kasapeteva, Aneliya Dakova, Valeri Slavchev, Diana Dakova ..... 90*

**P.E7 GENERATION OF AMPLITUDE VORTICES IN ISOTROPIC NONLINEAR MEDIA,**

*Valeri Slavchev, Aneliya Dakova-Mollova, Zara Kasapeteva, Kamen Kovachev, Diana Dakova, Lubomir Kovachev ..... 91*

**P.E8 DIRAC REPRESENTATION OF NONLINEAR MAXWELL EQUATIONS,**

*D. A. Georgieva, L. M. Kovachev ..... 92*

**P.E9 DARK SPATIAL SOLITONS IN ALKALI METAL VAPOR,**

*Nikola Nikolov, Stoyan Tsvetkov, Sanka Gateva ..... 92*

**P.E10 GOUY PHASE OF VORTEX NECKLACE AND ANNIHILATED VORTEX BEAMS,**

*Edmon Lazarov, Lyubomir Stoyanov, Maria Mincheva, Petko Drenkov, Nasko Gorunski, Alexander Dreischuh ..... 93*

**P.E11 GOUY PHASE DETERMINATION OF EVEN HERMITE-GAUSSIAN LASER MODES USING SINGLE-LENS INTERFEROMETER,**

*Maria Mincheva, Petko Drenkov, Edmon Lazarov, Nasko Gorunski, Lyubomir Stoyanov, Alexander Dreischuh ..... 94*

**F - ALTERNATIVE TECHNIQUES FOR MATERIAL SYNTHESIS AND PROCESSING**

**P.F1 SOME INITIAL RESULTS ON SYNTHESIS OF NANOPARTICLES FROM BaTiO<sub>3</sub> BY PULSED LASER ABLATION IN LIQUID MEDIA,**

*Ivaylo Balchev, Nadya Stankova, Dimitar Dimov, Desislava Karaivanova, Maria Gancheva, Reni Iordanova, Georgi Avdeev, Kaloyan Genkov, Anton Zypkov and Teodor Milenov ..... 96*

**P.F2 MODIFICATION OF THE STRUCTURE AND COMPOSITION OF TANTALUM OXYNITRIDE COATINGS DEPENDING ON THE DEPOSITION CONDITIONS,**

*N. Donkov, A. Zykova, V. Safonov, S. Dudin, S. Yakovin, M. Sawczak and G. Kolev ..... 97*

**P.F3 LINEAR AND BRANCHED HYDROPHILIC BLOCK COPOLYMERS DESIGNED FOR THIN-FILM OPTICAL SENSING APPLICATIONS,**

*Katerina Lazarova, Sijka Ivanova, Darinka Christova and Tsvetanka Babeva ..... 98*

**P.F4 PREPARATION OF IMPROVED CERIA CONVERSION COATINGS (CECC) FOR CORROSION PROTECTION OF Al 1050 ALLOY,**

*Reni Andreeva, Aleksandar Tsanev and Dimitar Stoychev ..... 99*

**P.F5 WIRE ARC DEPOSITION OF SPECIMENS USING ALUMINUM WELDING WIRE WITH Al-C COMPOSITE FLUX CORE,**

*G. Kotlarski, M. Ormanova, A. Nikitin, R. Ossenbrink, N. Doynov, S. Valkov and V. Michailov ..... 100*

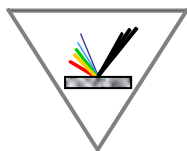

**P.F6 PREPARATION OF RGO AND COMPOSITES BY CLASSICAL AND ALTERNATIVE REDUCING AGENTS,**

*D. Kichukova, Ts. Lazarova, G. Atanasova, D. Kovacheva, I. Spassova ..... 101*

**P.F7 SOME INITIAL RESULTS ON FORMATION OF Si-O-C GLASSES DURING THE DIRECT CARBONIZATION OF Si SUBSTRATES - XPS AND GDOES STUDIES,**

*I. Avramova, I. Zahariev, V. Mehandziev, B. Blagoev, P. Rafailov, G. Avdeev, D. Karashanova, B. Georgieva, S. Kolev, D. Dimov and T. Milenov ..... 102*

**P.F8 DESIGN AND ELABORATION OF A MULTILAYER MIRROR FOR A LIDAR SYSTEM,**

*A. Tenev, E. Stoyanova, I. Miloushev, T. Tenev, K. Shumanov, I. Grigorov ..... 103*

**P.F9 ANALYZING PROTON TRANSFER RATE CONSTANTS IN TAUTOMERIC PROTON CRANES,**

*Lidia Zaharieva, Ivan Angelov and Liudmil Antonov ..... 104*

**P.F10 STRUCTURE AND ELECTRICAL PROPERTIES OF TiO<sub>x</sub> FILMS DEPOSITED ON COOPER SUBSTRATES,**

*D. Stoeva, M. Ormanova, G. Kotlarski, D. Dechev, N. Ivanov, S. Valkov, V. Mateev, I. Marinova ..... 105*

**P.F11 INFLUENCE OF ELECTRON-BEAM SURFACE TREATMENT ON THE CRYSTALLOGRAPHY OF Co-Cr-Mo ALLOYS,**

*F. Padikova, G. Kotlarski, B. Stoyanov, I. Parhorov, S. Parhorov, M. Ormanova, S. Valkov ..... 105*

**P.F12 INVESTIGATIONS ON THE INFLUENCE OF THE HEXAFERRITES SYNTHESIS ROUTE ON THEIR STRUCTURAL AND MAGNETIC PROPERTIES,**

*B. Georgieva, T. Koutzarova, S. Kolev, K. Krezhov, Ch. Ghelev, D. Kovacheva, P. Tzvetkov, L.-M. Tran, M. Babij, B. Vertruyen, R. Closset ..... 107*

**P.F13 DEVELOPMENT OF A WHITE-LIGHT GENERATOR FOR TRANSIENT ABSORPTION SPECTROSCOPY USING DIELECTRIC MULTILAYER COATINGS FOR SPECTRAL SMOOTHING,**

*E. Stoyanova, L. Petrov, A. Tenev, I. Miloushev, T. Tenev, D. Velkov, A. Trifonov and I. Buchvarov ..... 108*

**P.F14 ELASTOMERIC COMPOSITES FOR APPLICATION AS PRESSURE SENSORS,**

*Petrunka Malinova, Dimitar Dimov, Kamen Ivanov, Stefan Kolev, Dobromir Kalchevski, Aneliya Kostadinova, Teodor Milenov ..... 109*

**P.F15 STUDY OF THE LINE GRATING PROFILES IN PMMA BILAYER ON SiO<sub>2</sub>/Si SUBSTRATE AT 20 KEV ELECTRON ENERGY,**

*Robert Andok, Katia Vutova, Elena Koleva, Anna Bencurova, Mario Ritomsky and Ivan Kostic ..... 110*

**P.F16 STRUCTURAL AND MAGNETIC CHARACTERIZATION OF NANOSTRUCTURED ZnFe<sub>2</sub>O<sub>4</sub> SYNTHESIZED BY SONOCHEMISTRY,**

*K. Krezhov, L.-M. Tran, M. Babij, B. Georgieva, T. Malakova, S. Kolev, T. Koutzarova .... 111*



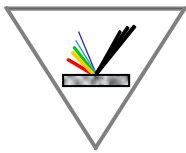

**XXIII International Conference and School on Quantum Electronics:  
“Laser Physics and Applications”**

**P.F17 Z-TYPE HEXAFERRITE: PREPARATION AND PROPERTIES,**  
*T. Malakova, K. Krezhov, S. Kolev, P. Peneva, Ch. Ghelev, B. Vertruyen, R. Closset, L.-M. Tran, M. Babij, P. Tzvetkov, D. Kovacheva, T. Koutzarova ..... 112*

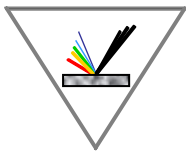

**XXIII International Conference and School on Quantum Electronics:  
“Laser Physics and Applications”**

## **INVITED LECTURES**

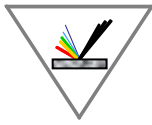

## INVITED LECTURES

---

### LASER - MATTER INTERACTIONS

#### IL.A1

#### LASER ADDITIVE MANUFACTURING: EXPERIMENTAL RESULTS VERSUS THEORETICAL MODELLING

Ion N. Mihailescu<sup>1,\*</sup>, Muhammad Arif Mahmood<sup>2</sup>, Cristian N. Mihailescu<sup>1</sup>, Mihai Oane<sup>1</sup>,  
Carmen Ristoscu<sup>1</sup>, Sinziana Andreea Anghel<sup>1,3</sup>, Andrei C. Popescu<sup>1</sup>, Diana Chioibas<sup>1</sup>

<sup>1</sup>*Laser Department, National Institute for Laser, Plasma and Radiation Physics (INFLPR),  
Ilfov-Magurele, 077125, Romania*

<sup>2</sup>*Intelligent Systems Center, Missouri University of Science and Technology,  
Rolla, MO, 65409, USA*

<sup>3</sup>*Faculty of Physics, University of Bucharest, Ilfov-Magurele, 077125, Romania*

*e-mail: [ion.mihailescu@inflpr.ro](mailto:ion.mihailescu@inflpr.ro)*

Recent progress will be reviewed in the laser additive manufacturing (LAM) technology for manufacturing near-net-shaped parts with many top applications and potential capabilities to enhance material properties, microstructural control, and overall performance. A computational fluid dynamics LAM model will be introduced based upon the fluid volume and discrete element modelling to describe the flow, pattern, and driving forces of the liquid. One supposes that LAM involves the simultaneous addition of powder particles that absorb a significant amount of laser energy when the laser beam irradiates the substrate and powder particles while the melt adopts a backwards flow due to the recoil pressure and thermocapillary or Benard–Marangoni convection effect, resulting in a negative mass flow rate. The developed model has been compared with experimental data obtained by LAM of various compounds (e.g., stainless steel, Ti and other metal alloys). A close correlation was evidenced between experiments and modelling, with a deviation of a few percent only. Pores are generated whenever the solid front hits the bubble before escaping the melt pool. The study aimed to overcome the difficulties associated with online rolling processes during AM, thus contributing to a more efficient manufacturing of metal components. New horizons of LAM extension will be explored, including 3D-printing of ceramics and plastic, surface polishing, sustainability, environmental impact.

**Keywords:** Laser Additive Manufacturing; melt flow; thermocapillary or Benard–Marangoni convection force; recoil pressure; flow pattern; mass flow rate directions.

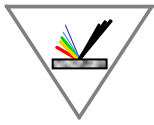

## IL.A2

### LASER-TITANIA INTERACTIONS: TOWARDS MANIPULATION OF MORPHOLOGY, STRUCTURE AND ELECTROCHEMICAL PROPERTIES

Katarzyna Grochowska

*Laboratory of Functional Materials, Centre of Plasma and Laser Engineering, Institute of  
Fluid-Flow Machinery, Polish Academy of Sciences, Fiszera 14 st., 80-231 Gdańsk, Poland*

*e-mail: [kgrochowska@imp.gda.pl](mailto:kgrochowska@imp.gda.pl)*

Herein, closed nanopillars from titania nanotube arrays modified by pulsed-laser treatment are proposed as an exemplary electrode material. Titanium oxide nanotubes (NTs) can be grown via an electrochemical process carried out in a two-electrode arrangement, where the Ti substrate acts as an anode. Such a fabrication approach ensures the growth of highly ordered architecture of titanium oxide NTs already onto the conductive substrate. After calcination at 450 °C, the oxide NTs are treated over any area and shape by laser beam precisely guided owing to the usage of a motorized X-Y stage. For the optimized geometry of nanotubes and laser working parameters, side selective plugging of nanocylinders can be achieved allowing unique structures. With the exception of closing the NTs tops, the remaining architecture of oxide support remains intact providing a straight percolation path [1].

Additional modification of the titania-based platform with, e.g., Au, Fe, Co, Ni and Cu magnetron-deposited layers prior to the laser treatment alters the optical properties as the metal species are accumulated at the top part of the capped NTs [2]. The electrochemical investigations of the prepared materials show that the intense light-matter interaction results in improved photocatalytic activity toward oxygen evolution reactions. Moreover, a precise laser sealing can also be used for the selective closing of nanotubes filled with the nanoparticles, e.g. luminescent ones, and then used for unique labelling.

Thus, the electrodes proposed could be further utilized in photonics or find electrochemical applications. Furthermore, easy upscaling can be achieved, since both anodization and laser treatment are well-mastered processes on a technological scale.

#### References:

[1] J. Wawrzyniak, J. Karczewski, P. Kupracz, K. Grochowska, E. Coy, A. Mazikowski, J. Ryl, K. Siuzdak, “Formation of the hollow nanopillar arrays through the laser-induced transformation of TiO<sub>2</sub> nanotubes”, *Sci. Rep.*, 10, 20235, (2020)

[2] J. Wawrzyniak, J. Karczewski, E. Coy, J. Ryl, K. Grochowska, K. Siuzdak, “Nanostructure of the laser-modified transition metal nanocomposites for water splitting”, *Nanotechnol.*, 33, 205401, (2022)

**Acknowledgements:** This work received financial support from the Polish National Science Centre: grant no 2021/41/B/ST8/01849.

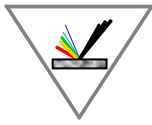

## IL.A3

### TOWARDS UNDERSTANDING GAS-PHASE CHEMISTRY DURING PULSED LASER DEPOSITION BY MEANS OF REAL-TIME PLASMA DIAGNOSTIC

Stefan A. Irimiciuc, Jan Lančok

*Institute of Physics of the Czech Academy of Sciences, Prague, Czech Republic*

*e-mail: [lancok@fzu.cz](mailto:lancok@fzu.cz)*

Amongst all plasma-based deposition techniques, pulsed laser deposition (PLD) stands as one of the best available technologies to develop complex stoichiometric films. Controlling and tailoring PLD has been the main developmental pillar in its history with the focus on external factors (laser fluence, gas pressure, target bias, target-substrate distance, etc.). However, to consider the laser-produced plasma as the active medium in the deposition, understanding its kinetics and controlling the complex chemistry occurring during the deposition become the key steps in developing a complete picture of the deposition process and AI algorithms and applications. In order to develop a complete picture of the deposition process, we employed a dual approach based on *in situ* plasma analysis and thin-film analysis to find common features that would connect the properties of the plasma with the ones of the deposit. *In situ* analysis of laser-produced plasmas generated in a wide range of deposition conditions were performed by an angular and time-resolved Langmuir probe (LP) technique and space- and time-resolved optical emission spectroscopy (OES).

The work was focused on understanding the complex oxidation chemistry occurring during transient plasma expansion in a PLD geometry in order to tailor the ionic energy distribution and control the oxidation phase in the film. A trademark feature of the study is the use of the angle- and time- resolved measurements during floating probe regime and show clear correspondences between the variation in plasma parameters and the generation of specific plasma phases. Plasma multi-structuring is observed for a wide range of pressures, with each feature corresponding to an ionization state of the plasma ions, results confirmed by OES investigations. Complementary, OES allowed angular, spatial and temporal monitoring of visible and UV emission of the plasma. Important results were found for the case of metallic deposition in O<sub>2</sub>, where we observed oxide molecules formation and its impact onto the plasma energy and the oxidation state of the coating. A key aspect in this lecture is to show proof of concept for oxide phase control via plasma diagnostic tools for a wide range of oxides (Ag<sub>x</sub>O<sub>y</sub>, Mn<sub>x</sub>O<sub>y</sub>, Cu<sub>x</sub>O<sub>y</sub>, NiO) with application in semiconductor industry. Confirmation of this control will be given by presenting the properties of the resulting thin films through a wide array of surface analysis techniques.

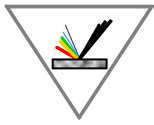

## IL.A4

**GIANT MAGNETOELECTRIC EFFECT IN  $(\text{Fe}_{80}\text{Co}_{20})_{80}\text{B}_{20}$  /  $\text{SrBi}_2\text{Ta}_2\text{O}_9$  SUB-MICRON BI-LAYER DEPOSITED BY “ECLIPSE” PULSED LASER DEPOSITION**  
**DEPOSITION OF FUNCTIONAL MULTI-LAYERED COATINGS BY PULSED PLASMA TECHNIQUES (PLD AND PED)**

R. I. Tomov\*, J. Robinson

*Department of Materials Science and Metallurgy, University of Cambridge, UK,  
27 Charles Babbage Road, Cambridge, CB3 0FS*

*e-mail: [rit21@cam.ac.uk](mailto:rit21@cam.ac.uk)*

Pulsed plasma deposition techniques have been playing a pivotal role in functional materials development for several decades. Pulsed Laser Deposition (PLD) and Pulsed Electron Deposition (PED) share a number of advantages typical for short-pulse transfer of multicomponent material. However, the techniques differ substantially in some important technological aspects. We illustrate the unique characteristics of both methods on specific examples related to the functional multi-layered coating applied to magnetic sensor technology, as well as secondary Li-ion batteries.

“Eclipse” pulsed laser deposition (ePLD) of polycrystalline  $\text{SrBi}_2\text{Ta}_2\text{O}_9$  (SBT) ferroelectric thin films on  $(\text{Fe}_{80}\text{Co}_{20})_{80}\text{B}_{20}/\text{Pt}/\text{TiO}_2/\text{SiO}_2/\text{Si}$  substrates was utilized for production of freestanding cantilevers. An effective strain-mediated coupling across the interface was demonstrated leading to a giant ME voltage coefficient at the fundamental resonance frequency  $\alpha_{E,31} = 140 \text{ V cm}^{-1} \text{ Oe}^{-1}$ . The PED process was utilised to transform commercial graphite material into carbon polymorph buffer interlayers with superior structural and transport properties, interposed with silicon layers from a second source for fabrication of high capacity Li-ion battery anodes. Composite CALIB C/Si anodes with layered architecture showed first cycle specific capacity of over  $2100 \text{ mAh g}^{-1}$  and retained capacity of  $\sim 1250 \text{ mAh g}^{-1}$  at  $1 \text{ A g}^{-1}$  rate. The energetic nature of the PED process was responsible for the specific characteristics of the mesoporous carbon matrix, which successfully accommodated the stress caused by alloying/de-alloying of silicon nano-layers thus preventing the pulverisation effect and preserving the structural integrity of the composite.

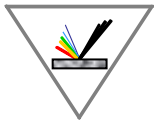

## LASER SPECTROSCOPY AND METROLOGY

### IL.B1

#### ATOM-SURFACE INTERACTION TURNED INTO A DIAGNOSTICS OF SPECTRALLY SHARP NEAR-FIELD THERMAL EMISSION BY A SURFACE POLARITON – COMPARISON WITH PREDICTIONS OF FAR-FIELD EMISSIVITY AND WITH ELLIPSOMETRY

J.C. de Aquino Carvalho<sup>1</sup>, I. Maurin<sup>1</sup>, P. Chaves de Souza Segundo<sup>1</sup>, A. Lalot<sup>1</sup>,  
D. de Sousa Meneses<sup>2</sup>, S. Hurand<sup>3</sup>, T. Martinez<sup>3</sup>, O. Rozenbaum<sup>2</sup>, D. Bloch<sup>1</sup>

<sup>1</sup>Laboratoire de Physique des Lasers CNRS and Sorbonne Paris Nord, F-93430 Villetaneuse

<sup>2</sup>CNRS, CEMHTI UPR 3079, Université d'Orléans, F-45071 Orléans

<sup>3</sup>CNRS, Laboratoire PPRIME UPR 3346, Site du Futuroscope, F- 86073 Poitiers

e-mail: [daniel.bloch@univ-paris13.fr](mailto:daniel.bloch@univ-paris13.fr)

Thermal emission in the near-field has been a topic of major interest since the turn of the century [1]. It strongly differs from the universal blackbody emission because of the coupling with evanescent modes of the emitting body enhanced for distances  $\leq hc/kT$  (i.e. 5-50  $\mu\text{m}$ ). Thermal emission becomes quasi-monochromatic in the extreme limit of near-field ( $\ll hc/kT$ ), as solely governed by surface modes. Precise predictions would be naturally of interest for a variety of novel applications (e.g. thermal diodes, thermal spectral lamp), but the predictions are material-dependent and demand an accurate estimate of the frequency of surface modes. These modes can even evolve with temperature, and are sensitive to the crystallographic orientation of the material.

For an ideal planar interface between a bulk medium and vacuum, the surface response, from which surface modes can be deduced, and which is totally dominant in the extreme near-field regime, is governed by the complex value  $S(\omega) = [\varepsilon(\omega) - 1] / [\varepsilon(\omega) + 1]$ , where  $\varepsilon(\omega)$  is the relative dielectric permittivity of the material at frequency  $\omega$ . This permittivity exhibits a temperature-dependence  $\varepsilon(\omega, T)$ . A difficulty is that the resonance for  $S(\omega, T)$  appears for  $\varepsilon(\omega, T) \sim -1$ , in a range far away from any resonance for  $\varepsilon(\omega)$ , where the material is moreover strongly absorbing – i.e. it is not an "optical window". The relative permittivity  $\varepsilon(\omega, T)$  is usually determined with experimental spectra of reflectivity (or equivalently, thermal emissivity) and an elaborate modelling, from which  $S(\omega)$  resonances are obtained. As  $\varepsilon(\omega)$  is complex-valued, an elaborate model [2] is considered for  $\varepsilon(\omega)$ , as an alternate to using the Kramers-Kronig relationship (which requires the entire spectrum).

For numerous years, a specific atomic spectroscopy was developed to measure the Casimir-Polder atom-surface interaction at distances  $\sim 100$  nm (see refs. in [3]). In the specific case of the excited Cs(7P) atom in front of a sapphire surface, thermally emitting sapphire can resonantly couple in the extreme near-field to an excited Cs(7P<sub>1/2</sub>) atom which absorbs at 12.15  $\mu\text{m}$  (24.678 THz or 0.102 eV), but not to the other fine-structure level Cs(7P<sub>3/2</sub>), where the equivalent absorption, at  $\sim 15$   $\mu\text{m}$ , is too far away. The strength of the resonant coupling, determined by a  $-C_3z^{-3}$  potential ( $z$ : the atom-surface distance) is governed by  $\Re[S(\omega, T)]$ . The measured  $C_3(T)$  has actually a growth smaller than expected from pure thermal statistics, owing to the broadening of the sapphire surface resonance with temperature [3]. However, the *ad hoc* emissivity measurements on the same sapphire window do not improve much the agreement. Also, a real energy transfer, expected from the sharper resonance for  $\Im[S(\omega)]$ , has remained

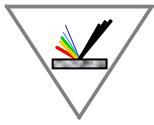

**XXIII International Conference and School on Quantum Electronics:  
“Laser Physics and Applications”**

unobserved [3]. The Lorentzian nature of  $S(\omega)$  around its resonance [4] led us to suspect [3] that the effective sapphire surface resonance could be red-shifted, and with a larger amplitude, relatively to predictions originating from bulk emissivity.

Surface resonances  $S(\omega)$  are more conveniently described by optical constants [index and absorption, i.e.  $\varepsilon(\omega) = (n+i\kappa)$ ], as the surface resonance, appearing when  $\varepsilon(\omega) \sim -1$ , requires  $\kappa \sim 1$  and  $n \ll 1$  [4]. Direct measurements of  $n$  and  $\kappa$  can be obtained by far IR ellipsometry. Our measurements, evidencing the temperature displacement of the sapphire surface resonance, still agree with estimates from emissivity, and include the analysis of sapphire birefringence. We will discuss possible limiting factors in our (near-field) atomic physics methods, and also intrinsic differences between near-field and far-field measurements.

**References:**

[1] A. V. Shchegrov, K. Joulain, R. Carminati, J-J. Greffet, “Near-field spectral effects due to electromagnetic surface excitations”, *Phys. Rev. Lett.*, 85(7), 1548, (2000)

[2] T. Passerat de Silans, I. Maurin, P. Chaves de Souza Segundo, S. Saltiel, M-P. Gorza, M. Ducloy, D. Bloch, D. de Sousa Meneses, P. Echegut, “Temperature dependence of the dielectric permittivity of  $\text{CaF}_2$ ,  $\text{BaF}_2$  and  $\text{Al}_2\text{O}_3$ : application to the prediction of a temperature-dependent van der Waals surface interaction exerted onto a neighbouring  $\text{Cs}(8P_{3/2})$  atom”, *J. Phys. Condens. Matter.*, 21, 255902, (2009)

[3] J. C. de Aquino Carvalho, I. Maurin, P. Chaves de Souza Segundo, A. Laliotis, D. de Sousa Meneses, D. Bloch, “Spectrally sharp near-field thermal emission: revealing some disagreements between a casimir-polder sensor and predictions from far-field emittance”, *Phys. Rev. Lett.*, 131(14), 143801, (2023)

[4] J. C. de Aquino Carvalho and D. Bloch, “Surface response around a sharply resonant surface polariton mode is simply a Lorentzian”, *Opt. Lett.*, 46(12), 2876-9, (2021)

**Acknowledgements:** J.C. A.C. was supported by Ciencias sem Fronteiras (Brazil). This project is partly supported by a CNRS-MITI interdisciplinary program.



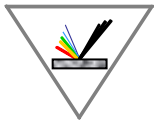

## IL.B2

### MULTIPLE ELECTRON DYNAMICS OF ATOMS IN STRONG FEMTOSECOND LASER FIELDS

Dmitry Efimov

*Institute of Theoretical Physics, Faculty of Fundamental Problems of Technology, Wrocław  
University of Science and Technology, 50-370 Wrocław, Poland*

*e-mail: [dmitry.efimov@pwr.edu.pl](mailto:dmitry.efimov@pwr.edu.pl)*

The laser fields in optical and near-infrared range of intensity of  $10^{13}$  W/cm<sup>2</sup> and higher are known to be strong enough to compete with the Coulomb interactions of valence electrons in atoms with atomic core. In such regime, the perturbation picture of atom-laser interaction is no longer valid; some highly non-linear effects like high-harmonic generation and correlated electron escape take place. Besides, the single active electron approximation becomes insufficient to describe even some one-electron observables; models considering several electrons are often needed for understanding experimental results. Additionally, if a laser pulse is short enough, for instance, several femtoseconds long, then the light and electronic spectra can shade light on internal many-electron dynamics of an atom. It has been a challenging task for both theoreticians and experimentalists to build an understanding of such complex processes. Yet successes in femto- and atto-second physics are very much desired: they are expected to lead to creating qualitatively new technologies in chemistry, electronics and optics. We shall discuss the recent progress in revealing properties of many-electron dynamics during strong-field ionization of atoms.

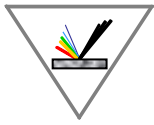

## LASER REMOTE SENSING AND ECOLOGY

### IL.C1

#### **THE ROLE OF THE EUROPEAN AEROSOL LIDAR NETWORK (EARLINET) IN THE AEROSOL, CLOUDS AND TRACE GASES RESEARCH INFRASTRUCTURE (ACTRIS)**

Adolfo Comerón, Constantino Muñoz-Porcar, Alejandro Rodríguez-Gómez

*CommSensLab, Dept. of Signal Theory and Communications, Universitat Politècnica de Catalunya BarcelonaTech. c/. Jordi Girona 1-3, 08034 Barcelona, Spain*

*e-mail: [comeron@tsc.upc.edu](mailto:comeron@tsc.upc.edu)*

ACTRIS (Aerosol, Clouds and Trace Gases Research Infrastructure, <https://www.actris.eu/>) is a research infrastructure of the European Research Area (ERA), formed currently by 17 EU-member or associated countries, under the legal entity of a European Research Infrastructure Consortium (ERIC). ACTRIS is devoted to providing research services, among which long-term, high-quality data series, on short-lived atmospheric constituents (aerosols, clouds and reactive trace gases) and their mutual interactions [1].

The European Aerosol Lidar Network (EARLINET, <https://www.earlinet.org/>), created in 2000 as a project of the 5<sup>th</sup> European R&D Framework Programme, provides to ACTRIS the vertical range-resolved aerosol measurement capability through its EARLINET/ACTRIS aerosol remote sensing National Facilities.

ACTRIS aerosol remote sensing National Facilities are required to operate lidars with the capability to measure independently aerosol backscatter and extinction coefficients (through the Raman or the high spectral resolution techniques) at one wavelength at least (ideally at the three wavelengths, 1064 nm, 532 nm and 355 nm, of a Nd:YAG laser with 2<sup>nd</sup>- and 3<sup>rd</sup>-harmonic generators), as well as depolarization at one wavelength (ideally at the three mentioned wavelengths). The lidar must be operated synergically with a close-by (less than 1 km) AERONET Sun/sky photometer for obtaining higher-level products, such as range-resolved fine and coarse particle mass concentration.

The requirements for high-quality products impose strict quality checks (QC) for the lidar instruments and quality-assurance (QA) protocols for the data to be made publicly available through the EARLINET/ACTRIS database. The EARLINET/ACTRIS database consists currently of QC/QA aerosol optical (extinction and backscatter) coefficients submitted by the different aerosol remote sensing facilities.

For the future, as part of a long-term research infrastructure, EARLINET strives to improve its capabilities with new techniques, such as fluorescence channels to enhance the aerosol typing abilities, also aiming at variables (water-vapor mixing ratio and temperature profiles) that impact the evolution of aerosols in ambient conditions.

In the presentation, the current configuration of the EARLINET/ACTRIS aerosol remote sensing facility of Barcelona will be described in detail.

#### **References:**

[1] P. Laj et al., “Aerosol, Clouds and Trace Gases Research Infrastructure (ACTRIS): “The European Research Infrastructure Supporting Atmospheric Science”, Bull. Amer. Meteor.

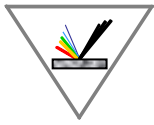

**XXIII International Conference and School on Quantum Electronics:  
“Laser Physics and Applications”**

Soc., 105, 7, E1098–E1136, (2024)

[2] G. Pappalardo et al., “EARLINET: towards an advanced sustainable European aerosol lidar network”, *Atmos. Meas. Tech.*, 7(8), 2389–2409, (2024)

## **IL.C2**

### **MEASURING THE ATMOSPHERE USING RAMAN SCATTERING LIDAR**

Geraint Vaughan

*National Centre for Atmospheric Science, Department of Earth and Environmental Sciences,  
University of Manchester, Manchester, UK*

*e-mail: [geraint.vaughan@manchester.ac.uk](mailto:geraint.vaughan@manchester.ac.uk)*

Raman scattering from atmospheric gases and particles is much weaker than elastic scattering but contains information specific to particular molecules. The lidar technique is based on directing high-power monochromatic laser pulses into the atmosphere and observing the backscattered radiation. Raman scattering is inelastic, i.e. it is shifted in wavelength from the laser beam. The presentation will describe how measuring the Raman components allows the derivation of aerosol extinction, atmospheric temperature, and gaseous composition, and suggests how the technique can be extended to other atmospheric parameters like particle properties.

## **IL.C3**

### **LIDAR INNOVATIONS FOR TECHNOLOGIES AND ENVIRONMENTAL SCIENCES (LITES): A FACILITY FOR SPECTROSCOPIC IN-SITU AND REMOTE SENSING ATMOSPHERIC STUDIES**

B. Tatarov<sup>1</sup> and D. Müller<sup>1</sup>

<sup>1</sup>*Department of Physics, Astronomy and Mathematics, School of Physics, Engineering and Computer Science, University of Hertfordshire, College Lane, Hatfield, United Kingdom*

*e-mail: [b.tatarov@herts.ac.uk](mailto:b.tatarov@herts.ac.uk)*

Atmospheric aerosols such as mineral dust, bio-aerosols and volcanic ash can be transported over tens of thousands of kilometers from its source regions. Despite an abundance of observations and modelling studies, large gaps remain in our understanding of the effect of mineral dust on air quality, human health, and climate.

Raman spectroscopy represents a particularly powerful tool for laser remote sensing because it allows us to both identify and quantify the chemical constituents in a complex aerosol mixture – as is often the case for atmospheric aerosol pollution. Nowadays, Raman lidar allows for an independent quantitative measurement of aerosol backscatter and extinction coefficient profiles with the use of Raman scattering from nitrogen or oxygen molecules. Previous works have shown that the detection of Raman scattering by silicone dioxide in a lidar receiver can be used to infer the concentration of mineral dust in the atmosphere. In recent years we have been developing a novel multi-channel spectrometric lidar system. This new approach will be used for detecting characteristic features of Raman spectra, which subsequently can be used for inferring chemical signatures of aerosol particles. To achieve this goal, we need currently

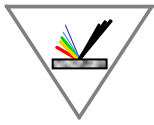

**XXIII International Conference and School on Quantum Electronics:  
“Laser Physics and Applications”**

unavailable information on the Raman spectra of aerosol species commonly found in the atmosphere.

We will present design and experimental results from a lidar facility that has been designed and built at the University of Hertfordshire. LITES (Lidar Innovations for Technologies and Environmental Sciences) allows for testing, developing and measuring a multitude of, e.g. climate-change relevant parameters of atmospheric particulate pollution and photo-chemically reactive trace gases. The core of LITES consists of a lidar spectroscopy instrument. In this contribution we present the design and specifications of the facility, its performance and potential applications. We will show examples of measurements of range-resolved pure rotational Raman spectra and rotational-vibrational Raman spectra of air molecules, aerosol and gas pollution.

In this contribution we will present also experimental results of Raman and fluorescence spectra of a collection of 50 different aerosol samples. These samples are well characterized in terms of their chemical composition. The samples include mineral dust (quartz, hematite, kaolinite, barite, calcite etc.), and bio-aerosols. We investigated these samples under laboratory conditions with a Raman microscope. The setup includes an Olympus BX51TRF-6 microscope with objective-lens magnifications x5, x10, x20, x50, and x100. The setup allow for a spatial resolution better than  $1\mu\text{m}$ . The Raman and fluorescence spectra are obtained with a HORIBA 1250M Research Spectrometer that uses four different gratings. The spectral resolution thus is better than  $1\text{cm}^{-1}$ . Data acquisition is done by a PI-MAX4 ICCD camera, an ANDOR iXon 3 EMCCD camera, Newton DU920P-BEX2-DD camera, photo multiplier tubes, and Si and InGaAs detectors.

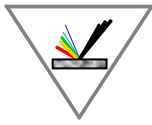

## LASERS IN BIOLOGY AND MEDICINE

### IL.D1

#### LASER-INDUCED BREAKDOWN SPECTROSCOPY FOR DIRECT DETERMINATION OF HEAVY METALS IN OILS

Milica Vinić<sup>1</sup>

<sup>1</sup>*Institute of Physics, University of Belgrade, Pregrevica 118, Belgrade, Serbia*

*e-mail: [mvinic@ipb.ac.rs](mailto:mvinic@ipb.ac.rs)*

The study presents a detailed methodology for the preparation and analysis of oil samples using Laser Induced Breakdown Spectroscopy (LIBS) in order to enhance detection sensitivity and measurement repeatability while minimizing sample volume and matrix effects. The preparation process involves stabilizing the oil sample and silica wafer substrate at a fixed temperature of 40°C and applying an oil droplet on the rotating wafer using a spin coater to create a uniform oil film of controlled thickness.

Comparative measurements were conducted on pure oil and oil with 2100 ppm of various elements to investigate potential sources of matrix effects. It was observed that the volume sampled by LIBS remained the same despite different kinematic viscosities of oils, and that the transmissivity of the oil is decreased with impurity concentration, but this effect could be neglected for very thin films [1].

The study also characterized the plasma induced by a nanosecond Nd:YAG laser on thin oil films, thus revealing time-resolved plasma parameters such as spectral line intensities, electron number density, and plasma temperature. The electron number density ranged from  $1.1 \times 10^{17} \text{ cm}^{-3}$  to  $1.5 \times 10^{16} \text{ cm}^{-3}$  at different time delays, and the plasma temperature varied from 9400 K to 7200 K. Rotational and vibrational temperature evaluations were conducted using emission spectra of C<sub>2</sub> and CN molecules [2].

Under optimized experimental conditions, the LIBS analysis achieved detection limits of 3.9 ppm for Zn, 0.49 ppm for Cd, 0.16 ppm for Cu, and 0.082 ppm for Cr in oil. By carefully selecting signal acquisition delays and calibration procedures based on excitation energy, the study successfully demonstrated the effectiveness of LIBS for elemental analysis in oils with high sensitivity and precision [1].

#### References:

[1] M. Vinić, E. Aruffo, F. Andreoli, M. Ivković, V. Lazic, “Quantification of heavy metals in oils with  $\mu\text{l}$  volume by Laser Induced Breakdown Spectroscopy (LIBS) and minimizing of the matrix effect”, *Spectrochim. Acta Part B: At. Spectrosc.*, 164, 105765, (2020)

[2] M. Vinić, M. Kuzmanovic, J. Savovic, M. Ivkovic, “Diagnostics of laser-induced plasma from a thin film of oil on a silica wafer”, *J. Serb. Chem. Soc.*, 87, 1-13, (2023)

**Acknowledgements:** The research was funded by the Ministry of Education, Science and Technological Development of the Republic of Serbia, Contract numbers: 451-03-9/2021-14/200024, 451-03-9/2021-14/200146, and 451-03-9/2021-14/200017. Milica Vinić acknowledges ENEA (Italy) for supporting her work on the collection of experimental data presented in this work. The author acknowledges Dr. Violeta Lazić from ENEA (Italy) for providing the experimental data used in this work and for helpful scientific discussions.

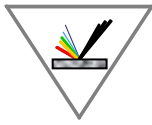

## IL.D2

### NONLINEAR IMAGING AND LASER NANO-SURGERY OF FUNGAL CELLS TO ENABLE ELECTROPHYSIOLOGICAL MEASUREMENTS

Tanja Pajić<sup>1</sup>, Katarina Stevanović<sup>1</sup>, Nataša Todorović<sup>2</sup>, Steva Lević<sup>3</sup>, Svetlana Savić Šević<sup>4</sup>,  
Dejan Pantelić<sup>4</sup>, Miroslav Živić<sup>1</sup>, Mihailo Rabasović<sup>4</sup> and Aleksandar Krmpot<sup>4</sup>

<sup>1</sup>*Faculty of Biology, University of Belgrade, Belgrade, Serbia*

<sup>2</sup>*Siniša Stanković Institute for Biological Research, University of Belgrade, Serbia*

<sup>3</sup>*Faculty of Agriculture, University of Belgrade, Serbia*

<sup>4</sup>*Institute of Physics Belgrade, University of Belgrade, Serbia*

*e-mail: [krmpot@ipb.ac.rs](mailto:krmpot@ipb.ac.rs)*

Electrophysiology studies of ion channels in live filamentous fungi by the patch clamp method are not possible due to presence of rigid chitinous cell wall that prevents the patch clamp pipette to access the plasma membrane. We present laser nano-surgery of the fungal cell wall that enables patch clamp electrophysiology studies. Similar approaches as one-time reports utilizing nanosecond laser pulses long time ago were not pursued further [1,2]. Here, we demonstrate reproducible method using femtosecond lasers accompanied by two-photon excitation fluorescence (TPEF) imaging of hyphae.

A wild-type strain of filamentous fungus *Phycomyces blakesleeanus* (Burgeff) [NRRL 1555(-)] were grown on glass coverslips with hand-etched grid coated with a thin layer of 50% collagen type I as an immobilizer. A home-built nonlinear laser scanning microscope [3,4] utilizing a Ti:Sa tunable fs laser was used for TPEF imaging of hyphae and cell surgery. The latter was enabled with a custom-made add-on to software. A coverslip with hyphae was transferred to another microscope setup for patch clamp consisting of micromanipulators and precise electronics for pA current measurements. The surgical incisions and released protoplasts were additionally imaged by scanning electron microscopy for which the treated hyphae had to undergo a critical point drying procedure.

Hyphae were stained by Calcofluor White and treated by an exocytosis inhibitor (brefeldin A) and a respiration inhibitor (sodium azide) to prevent cell wall regeneration. Since the cell wall and the plasma membrane are in the close contact [4], the hyphae were kept in hyperosmotic solution to retract the cytoplasm from the cell wall. Surgical spot-wise pattern was precisely positioned at TPEF image of selected hypha at the place where the plasma membrane was retracted. The dwell time (1 s) and the laser power (4-15 mW) were set with a fixed repetition rate (76 MHz), pulse duration (160 fs) and laser wavelength (730 nm). Upon the surgery, hyphae were gently deplasmolysed. A protoplast with plasma membrane accessible for the patch clamp pipette was released through the surgical incision. A seal resistance  $>G\Omega$  was achieved. Numerous ion channels were recorded in different configurations (on cell, inside-out, whole cell and out-out).

The whole process (cell surgery + patch clamping) is rather complex and specific steps have to be strictly followed for high success rate and reproducibility. Also, the chemicals concentrations, solutions osmolarity, timing and cutting parameters have to be kept in the specified narrow range. The current recordings obtained provide valuable information on fungal cell membrane ionic channels.

#### References:

[1] S.K. Roberts et al, “Laser Ablation of the Cell Wall and Localized Patch Clamping

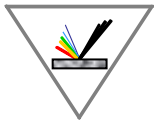

**XXIII International Conference and School on Quantum Electronics:  
“Laser Physics and Applications”**

of the Plasma Membrane in the Filamentous Fungus *Aspergillus*: Characterization of an Anion-Selective Efflux Channel”, *The New Phytologist*, 137, 579-85, (1997)

[2] A.A. Véry, J.M. Davies, “Laser microsurgery permits fungal plasma membrane single-ion-channel resolution at the hyphal tip”, *Applied and Environmental Microbiology*, 64, 1569-72, (1998)

[3] M.D. Rabasović et al, “Nonlinear microscopy of chitin and chitinous structures: a case study of two cave-dwelling insects”, *Journal of Biomedical Optics*, 20, 016010, (2015)

[4] T Pajić et al, “Label-free third harmonic generation imaging and quantification of lipid droplets in live filamentous fungi”, *Scientific Reports*, 12, 18760, (2022)

**Acknowledgements:** Project BioPhysFUN [Grant number 4545] from Program GREEN, Science Fund of the Republic of Serbia; and all institutions from the affiliations, through the grant by the Ministry of Education, Science and Technological Development of the Republic of Serbia.

## **IL.D3**

### **NANOARCHAEOSOMES COUPLED GOLD NANORODS: A SYNERGISTIC APPROACH TO CHEMO-PHOTOTHERMAL CANCER THERAPY**

Shaik Sameer Basha<sup>1</sup>, Poornima Budime Santhosh<sup>2,3</sup>, Lyubomir Stoychev<sup>2</sup>, Julia Genova<sup>2</sup>,  
Swathi Sudhakar<sup>1\*</sup>

<sup>1</sup>*Department of Applied Mechanics and Biomedical Engineering, Indian Institute of Technology Madras, Chennai, India*

<sup>2</sup>*Institute of Solid State Physics, Bulgarian Academy of Sciences, Tsarigradsko Chaussee 72, 1784 Sofia, Bulgaria*

<sup>3</sup>*Central Laboratory of Solar Energy and New Energy Sources, 72 Tsarigradsko Chaussee, 1784 Sofia, Bulgaria*

*e-mail: [swathi.s@iitm.ac.in](mailto:swathi.s@iitm.ac.in)*

Recent advances making use of near-infrared (NIR) lasers and gold nanorods (AuNRs) have paved the way to innovative cancer treatment strategies<sup>1</sup>. In this work, we propose a NIR laser-induced synergistic chemo-phototherapeutic approach by fabricating the nanoarchaeosomes (NA), which are novel, nano-sized liposomes synthesized from archaeal lipids, encapsulated with the PEGylated gold nanorods (PEG-AuNRs) and cisplatin (CIS), an anticancer drug. Comprehensive characterization techniques, including transmission electron microscopy (TEM), dynamic light scattering (DLS), and UV-Vis spectroscopy, confirmed the successful synthesis of the NA-PEG-AuNR-CIS complex. Under irradiation by an 808-nm wavelength laser (1 W/cm<sup>2</sup>, 5 min), the AuNRs effectively induced localized photothermia and controlled drug release from the NA. *In vitro* studies on MCF-7 breast cancer cells demonstrated that this complex exhibits enhanced cellular uptake and a significant reduction in the cell viability. Our findings suggest that not only does our system enhance the therapeutic index of the drug, but it also minimizes systemic toxicity and paves the way to a more efficient and less invasive cancer treatment method.

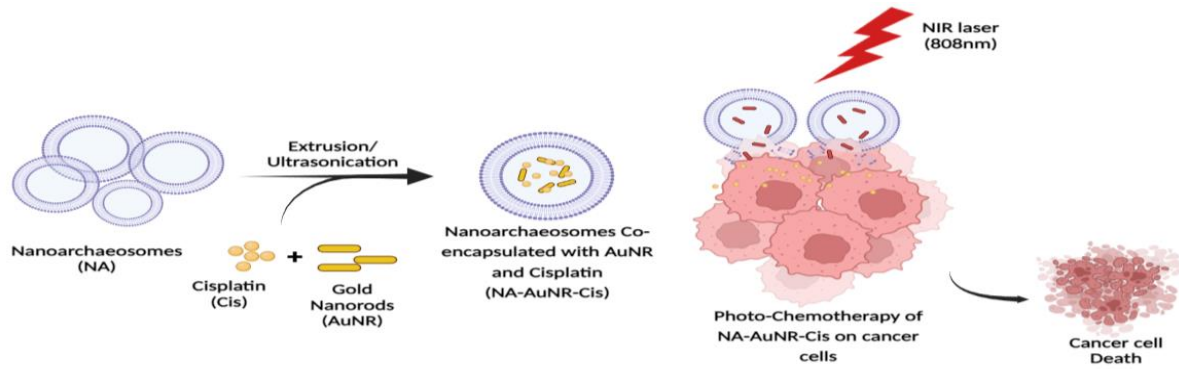
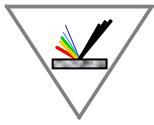

**Figure 1:** Schematic representation of NIR laser induced photo-chemothermal cancer therapy

#### References:

[1] M. Deinavizadeh, *et al.*, “Synergistic chemo-photothermal therapy using gold nanorods supported on thiol-functionalized mesoporous silica”, *Sci. Rep.*, 14, 4373, (2024)

**Acknowledgements:** The authors acknowledge financial support from the Bulgarian National Science Fund under project Grant No: KP-06-N78/8 (14.12.2023) and fund from Indian Government Grant No: SP23242582AMSERB009000, & IP23242000AMIITM009000.

## IL.D4

### OPTICAL DIAGNOSIS OF TISSUE WITH IMAGING MUELLER POLARIMETRY

Tatiana Novikova<sup>1,2</sup>

<sup>1</sup>*LPICM, CNRS, Ecole polytechnique, IP Paris, Route de Saclay, Palaiseau, 91120, France*

<sup>2</sup>*Department of Biomedical Engineering, Florida International University, 10555 West Flagler Street, Miami, FL 33174, USA*

*e-mail: [tatiana.novikova@polytechnique.edu](mailto:tatiana.novikova@polytechnique.edu)*

Optical techniques based on polarization have proved to be quite sensitive to early changes in tissues’ optical properties are induced by pathologies [1]. These techniques already serve as a diagnostic tool for rapid non-contact assessment of biological tissue at both macro- and microscale.

In particular, imaging Mueller polarimetry is capable of detecting and quantifying the optical anisotropy and depolarization properties of biological tissues [2]. It was shown that polarimetric maps of these parameters increase the contrast between the healthy and the pathological zones of tissue and may be used for the diagnosis of a disease using statistical analysis and machine learning approach [3, 4].

Recent advances in imaging Mueller polarimetry showing a significant potential for both pre-clinical and clinical applications will be discussed along with the prospects.

#### References:

[1] J. C. Ramella-Roman, T. Novikova (Eds) *Polarized Light in Biomedical Imaging and Sensing - Clinical and Pre-Clinical Applications* (Springer Cham, 2023)

[2] L. Felger, O. Rodriguez-Nunez, R. Gros, T. Maragkou, R. McKinley, S. Moriconi, M. Murek, I. Zubak, T. Novikova, A. Pierangelo, P. Schucht, “Robustness of the wide-field imaging Muller polarimetry for brain tissue differentiation and white matter fiber tract



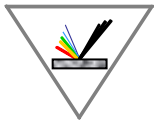

**XXIII International Conference and School on Quantum Electronics:  
“Laser Physics and Applications”**

identification in surgery-like environment – an ex vivo study”, *Biomed. Opt. Express*, 14, 5, 2400-2415, (2023)

[3] D. Robinson, W. B. Kleijn, K. Hoong, A. Doronin, J. Rehbinder, J. Vizet, A. Pierangelo, T. Novikova, “Polarimetric imaging for cervical pre-cancer screening aided by machine learning: ex vivo studies”, *J. Biomed. Opt.*, 28, 10, 102904, (2023)

[4] M. Kim, H. R. Lee, R. Ossikovski, A. Malfait-Jobart, D. Lamarque, T. Novikova, “Optical diagnosis of gastric tissue biopsies with Mueller microscopy and statistical analysis”, *J. Europ. Opt. Soc. Rapid Publ.*, 18(2), 10, (2022)

**Acknowledgements:** This work is supported in part by the funds from the Swiss National Science Foundation (Sinergia grant HORA0 #CRSII5 205904).

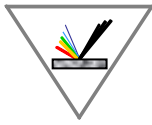

**LASER SYSTEMS AND NONLINEAR OPTICS**

**IL.E1**

**THE CHALLENGES OF THE APPLICATIONS OF PW LASER-PLASMAS**

J.C. Kieffer

INRS-EMT, Varennes, Canada

*e-mail:* [kieffer@emt.inrs.ca](mailto:kieffer@emt.inrs.ca)

Ultrafast laser technology has been developed to extreme power over the past years, and 10 PW beams are now operating on target at ELI-NP in Romania. From high field physics to particle acceleration to very high energies, these lasers are paving the way to a wide range of applications, including among other aspects the Inertial Fusion Energy, the production of radioisotopes, cancer imaging, and gamma rays for inspection technologies. This presentation reviews the technology, strategic and operational challenges faced if we want to apply the PW technology to societal and industrial problems and describes the role of large laser infrastructures (with ELI as an example).

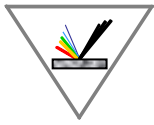

## ALTERNATIVE TECHNIQUES FOR MATERIAL SYNTHESIS AND PROCESSING

### IL.F1

#### CHARGED-PARTICLE-BEAM LITHOGRAPHY

Ivan Kostic<sup>1</sup>, Katia Vutova<sup>2</sup>

<sup>1</sup>*Institute of Informatics, Slovak Academy of Sciences, Dubravska cesta 9, 845 07 Bratislava,  
Slovak Republic*

<sup>2</sup>*Institute of Electronics, Bulgarian Academy of Sciences, 72 Tsarigradsko Chaussee Blvd,  
1784 Sofia, Bulgaria*

*e-mail: [ivan.kostic@savba.sk](mailto:ivan.kostic@savba.sk)*

The aim of this lecture is to provide an overview of charged-particle-beam lithography, including electron-beam nanolithography, ion-beam nanolithography, and electron-beam-induced deposition. The focus is on the electron-beam lithography (EBL) as a crucial technology for top-down nanofabrication in the preparation of nanometer structures. In research and development (R&D), EBL is used in a wide range of applications, including nanoelectronics, molecular electronics, quantum devices, sensors, optoelectronics, nanophotonics, high-frequency electronics, spintronics, quantum dots, nanomechanical devices, nanosystems, the production of nanoimprint templates, and more.

EBL is a direct patterning technique, meaning that nanopatterns are generated in a sequential manner. As a result, it has low throughput and is suitable for R&D or the production of photomasks and nanoimprint molds.

Studies in electron-beam lithography primarily focus on resist properties, resist sidewall shape control by EBL of either single-layer or multi-layer structures, and pattern transfer through either lift-off or etching. An overview of various common resists will be provided. To date, the most common high-resolution EBL resists can be categorized according to their working principles into two main groups. One group includes polymer resists (e.g., polymethyl-methacrylate (PMMA) with various molecular weights, PMMA/MAA, ZEP, and the inorganic negative resist HSQ). The other group comprises chemically amplified resists (CARs) (e.g., UVIII, UVN-30, SU-8, SAL-601, NEB, and Calixarene).

The resist sidewall shape depends on several parameters: beam energy and current, exposure dose, beam size and shape, substrate properties, chemical composition of the resist, development process conditions, and proximity effect. Achieving high-quality patterns with precisely defined sidewalls requires experimentation, simulation, and process optimization.

An important part of process optimization is the simulation of the resist sidewall shape. Examples of simulation results for the sidewall shape developed at different exposure doses are presented for PMMA, ARN, SU-8, and HSQ resists.

**Acknowledgements:** This work was supported by the Bulgarian Academy of Sciences within the SAS-BAS joint research project IC-SK/01/2023-2024, by the Slovak Academy of Sciences within the joint research project SAS-BAS-2022-05, and by the Ministry of Education of the Slovak Republic and the Slovak Academy of Sciences under the contract VEGA 2/0099/22.

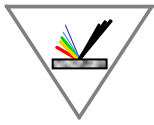

## IL.F2

### ADDITIVE MANUFACTURING OF BIOCERAMICS: STATE OF THE ART AND BEYOND

Nicolas Somers

*GREENMAT, CESAM Research Unit, University of Liege, 4000 Liège, Belgium*

*e-mail: [nsomers@uliege.be](mailto:nsomers@uliege.be)*

Additive manufacturing (AM) of ceramics is a timely topic because it allows one to produce customized functional ceramic parts with geometrical complexity, very useful in the medical field. Currently, AM is achieved most commonly through multistep “indirect” processes requiring supplementary steps, such as debinding and sintering. Particularly interesting would be the ability to directly manufacture ceramic parts from a single-step AM method without the need to apply high pressures nor post-process sintering of the final ceramic part. Reaching this goal will require acceleration of each process step (debinding, sintering, etc.) or re-considering the entire process flow. Several single-step processes have been developed over the years for ceramic materials using lasers or electron beams. Depending on the beam power and the processed materials, the thermal beam energy irradiating the powder particles can initiate either full melting of the powder particles, partial melting of the powder particles, solid-state sintering of the powder, a chemical reaction of the powder particles, or the formation of a three-dimensional (3D) network that entraps the powder particles.

Lasers can also be used in indirect processes like stereolithography, especially ultraviolet (UV) lasers that can cure photosensitive polymers. Ceramic stereolithography produces 3D ceramic parts by selectively irradiating and solidifying/photopolymerizing layers of liquid resins made of photocurable monomers and ceramic powders. However, obtaining pure ceramic parts requires that these printed bodies be subjected to appropriate thermal treatments that first remove the organic phase (debinding) and then densify (sinter) the part to achieve acceptable mechanical properties.

Another approach may be to combine photonic heating technologies (xenon flash lamps or IR irradiation), which can quickly deliver a large amount of energy, with AM processes and inorganic binders that can be directly converted into intergranular ceramic phases that bind the ceramic part together. When converted into monolithic parts, these binders are sometimes known as “chemically bonded ceramics,” rather than “sintered ceramics.” The challenge is that the inorganics need to form reasonably strong bonds in the “as printed” state to keep the green body's shape. Then, the printed part can react rapidly under the light irradiation into a bonded ceramic phase with a minimal volume loss. The use of aluminum dihydrogen phosphate ( $\text{Al}(\text{H}_2\text{PO}_4)_3$ , ADP), an inorganic binder, is investigated in combination with oxide ceramics and photonic curing to develop an alternative direct AM process for ceramic parts. This innovative technique could find promising applications in the bioceramics field due to its applicability to a wide range of materials.

Collaborators: Alejandro Monton, Eren Ozmen, Mark D. Losego (School of Materials Science and Engineering, Georgia Institute of Technology, Atlanta, Georgia, USA)

#### References:

[1] N. Somers, A. Montón, E. Özmen, M. D. Losego, “Infrared irradiation to drive phosphate condensation as a route to direct additive manufacturing of oxide ceramics”, *J. Am. Ceram. Soc.*, 107, 36-46, (2023)

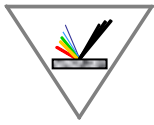

[2] N. Somers, E. Ozmen, M. D. Losego, “Hydrothermal treatment of alumina powders to alter the low-temperature binding of chemically bonded phosphate ceramic composites via infrared irradiation”, *J. Mater. Sci.*, 59(10), 4089-4101, (2024)

[3] E. Özmen, N. Somers, M. D. Losego, “Rapid, Direct Fabrication of Thermochromic Ceramic Composite Sensors via Flash Lamp Annealing”, *Adv. Eng. Mater.*, 26, 2400323, (2024)

## IL.F3

### FABRICATION, CHARACTERIZATION AND APPLICATION OF 1D SEMICONDUCTOR NANOMATERIALS

Muhammad Bilal Khan<sup>1</sup>, Ahmad Echresh<sup>1</sup>, Sayantan Ghosh<sup>1</sup>, Phanish Chava<sup>1</sup>, Muhammad Moazzam Khan<sup>1</sup>, Oliver Steuer<sup>1</sup>, Slawomir Prucnal<sup>1</sup>, René Hübner<sup>1</sup>, Lars Rebohle<sup>1</sup>, Shengqiang Zhou<sup>1</sup>, Manfred Helm<sup>1,2,3</sup>, Artur Erbe<sup>1,2,3</sup>, Yordan M. Georgiev<sup>1,4</sup>

<sup>1</sup>*Institute of Ion Beam Physics and Materials Research, Helmholtz-Zentrum Dresden-Rossendorf (HZDR), Bautzner Landstrasse 400, 01328 Dresden, Germany*

<sup>2</sup>*Technische Universität Dresden, Centre for Advancing Electronics Dresden (CfAED), 01069 Dresden, Germany*

<sup>3</sup>*Technische Universität Dresden, Institute of Applied Physics, 01069 Dresden, Germany*

<sup>4</sup>*Institute of Electronics, Bulgarian Academy of Sciences, 72 Tsarigradsko Chaussee Blvd., 1784 Sofia, Bulgaria*

email: [y.georgiev@hzdr.de](mailto:y.georgiev@hzdr.de)

1D semiconductor nanomaterials, such as nanowires (NWs) and nanosheets (NSs), have attracted a lot of attention in the last two decades because of their appealing electrical, optical and mechanical properties. In the wide range of such materials, the NWs and NSs based on group IV elements deserve special consideration. Besides the extensively studied silicon (Si) and germanium (Ge), their alloys with tin (Sn) – GeSn and SiGeSn – are very promising due to a number of unique properties. Sn concentrations in the range of 3-15% allow effective bandgap engineering, as well as achieving high charge carrier mobility and even a direct-bandgap group IV semiconductor. This makes the SiGeSn alloy systems ideal for post-Si-based nanoelectronic and optoelectronic applications, since they combine the flexibility and mobility gain of III/V compound semiconductors and heterostructures with the well-developed Si processing technology.

In this talk, we will first discuss the top-down fabrication of Si, Ge and alloy NWs with varying content of the different elements ( $\text{Si}_{1-x-y}\text{Ge}_y\text{Sn}_x$ ). Furthermore, we will consider their challenging structural and electrical characterization, paying special attention to the transmission electron microscopy (TEM) and the Hall effect measurements using a novel six-contact Hall bar configuration with symmetric contact bars located opposite to each other. This configuration allows reliable evaluation of the electrical properties of even very small nanowires with widths down to 20-30 nm, as well as quantification of such parameters as carrier concentration ( $n$ ), Hall mobility ( $\mu_H$ ), and resistivity ( $\rho$ ).

Finally, some advanced nanoelectronic devices based on the fabricated NWs will be reviewed, in particular junctionless nanowire transistors (JNTs) and reconfigurable field effect transistors (RFETs). Different configurations of such devices will be discussed, together with their

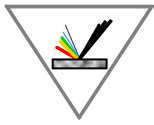

**XXIII International Conference and School on Quantum Electronics:  
“Laser Physics and Applications”**

structural and electrical characterization. A special focus will be put on Si JNTs for sensing applications, as well as on Si, Ge, SiGe, GeSn and SiGeSn JNTs and RFETs for digital logic.

**Acknowledgements:** This work was partially supported by the German Bundesministerium für Bildung und Forschung (BMBF) under the project "ForMikro": Group IV heterostructures for high performance nanoelectronic devices (SiGeSn NanoFETs), Project-ID: 16ES1075, and by the European Union's Horizon 2020 Research and Innovation programme under the project RADICAL, Grant Agreement No. 899282. We gratefully acknowledge the HZDR Ion Beam Centre and nanofabrication facility NanoFaRo.

## **IL.F4**

### **THE SUM OF ALL FEARS: PHYSICAL CHALLENGES IN THE RETICLE DEFECTIVITY OF THE ASML HIGH-NA EUV LITHOGRAPHY SYSTEMS**

Georgi Nenchev

*Senior Architect, Design & Engineering ASML Holding N.V., Veldhoven, The Netherlands*

*e-mail: [georgi.nenchev@asml.com](mailto:georgi.nenchev@asml.com)*

For the last 70 years, the computers have revolutionized the way we live and communicate. What made this revolution possible was the triumph of the planar semiconductor technology – the ability to create shrinking in size (and increasing in counts) arrays of logical elements over the surface of a plain silicon wafer. In turn, what made "the shrink" (and the related Moore's Law) enduring was the progress of the photolithography instruments – the increase of the resolution by going to lower wavelengths and higher apertures, plus the increased scanning speeds. But as we approach the EUV wavelength and the quantum limits of systems, new challenges emerge. In this presentation I will describe some of the complexities of the physical processes that drive EUV reticle defectivity - how the combination of "gas curtains", plasma generation, electrical and thermal fields create problems which are impossible to solve by analytical means - and are very challenging for even crude numerical simulation. We will look at the models that we have and compare their results with the phenomena that we observe in real life. A conclusion will be made as to how we can impact critical deliverables like defectivity and lifetime by simplifying the system ("ground everything") and trading throughput (velocity) for reliability, so as to eventually keep Moore's law alive for the next generation of systems, technologists and consumers.

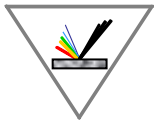

**XXIII International Conference and School on Quantum Electronics:  
“Laser Physics and Applications”**

**ORAL SESSIONS**  
**PRESENTED CONTRIBUTIONS**

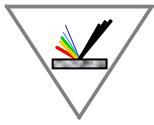

## ORAL PRESENTATIONS

---

---

### ORAL PRESENTATIONS – Session I

#### OP.F1

#### NEAR-INFRARED PHOTODETECTORS BASED ON SINGLE GERMANIUM NANOWIRES

Ahmad Echresh<sup>1</sup>, Mohd Saif Shaikh<sup>1</sup>, Mircea Traian Catuneanu<sup>2</sup>, Artur Erbe<sup>1,2</sup>, Lars Rebohle<sup>1</sup>, Kambiz Jamshidi<sup>2</sup>, Yonder Berencén<sup>1</sup>, Yordan M. Georgiev<sup>1,3</sup>

<sup>1</sup>*Institute of Ion Beam Physics and Materials Research, Helmholtz-Zentrum Dresden-Rossendorf (HZDR), Dresden, 01328, Germany*

<sup>2</sup>*Technische Universität Dresden, 01062 Dresden, Germany*

<sup>3</sup>*Institute of Electronics, Bulgarian Academy of Sciences, 1784 Sofia, Bulgaria*

*e-mail: [a.echresh@hzdr.de](mailto:a.echresh@hzdr.de)*

Germanium (Ge) is a promising candidate for designing near-infrared photodetectors because of its bandgap (0.66 eV), which exhibits a large absorption coefficient at near-infrared wavelengths. Also, Ge has excellent compatibility with parallel processing common in silicon technology [1,2]. The observation of high responsivity in semiconductor nanowires (NWs) with a high surface-to-volume ratio has attracted growing interest in using NWs in photodetectors. So far, significant efforts have been made to fabricate single NW-based photodetectors with different materials such as Si, Ge, and GaN to achieve miniaturized devices with high responsivity and short response time [3-5]. Hence, Ge nanowires are excellent candidates to fabricate single nanowire-based near-infrared photodetectors.

In this work, we report on the fabrication and characterization of an axial p–n junction along Ge NWs. First, Ge layers were locally doped with phosphorus ions using ion implantation followed by rear-side flash lamp annealing. Then, single Ge NWs with an axial p–n junction were fabricated via the top-down approach. The fabricated devices demonstrate the rectifying current–voltage characteristic of a p–n diode in dark conditions. Moreover, the response characteristics of the axial p–n junction-based photodetectors were investigated under light illumination of 850 nm laser. The experiments indicated that the fabricated photodetectors could be operated at zero bias under illumination and high responsivity of 1.72 AW<sup>-1</sup> was determined at reverse bias. Moreover, the fabricated photodetectors exhibit a high-frequency response with 3dB cut-off frequency of 2.4 GHz, which makes them promising candidates for light-wave communication switches [6].

#### References:

- [1] L. Virot, D. Benedikovic, B. Szelag, et al., “Integrated waveguide PIN photodiodes exploiting lateral Si/Ge/Si heterojunction”, *Opt. Express*, 25, 19487–19496, (2017)
- [2] W. Chen, R. Liang, S. Zhang, et al., “Ultrahigh sensitive near-infrared photodetectors based on MoTe<sub>2</sub>/germanium heterostructure” *Nano Res.*, 13, 127–132, (2020)
- [3] K. Das, S. Mukherjee, S. Manna, et al., “Single Si nanowire (diameter ≤ 100 nm) based polarization sensitive near-infrared photodetector with ultra-high responsivity”, *Nanoscale*, 6, 11232–11239, (2014)



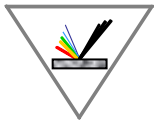

**XXIII International Conference and School on Quantum Electronics:  
“Laser Physics and Applications”**

[4] S. Cuesta, M. Spies, V. Boureau, et al., “Effect of bias on the response of GaN axial p–n junction single-nanowire photodetectors”, *Nano Lett.*, 19, 5506–5514, (2019)

[5] S. Mukherjee, K. Das, S. Das, and S. K. Ray, “Highly responsive, polarization sensitive, self-biased single GeO<sub>2</sub>-Ge nanowire device for broadband and low power photodetectors”, *ACS Photonics*, 5, 4170–4178, (2018)

[6] C. Xie, B. Nie, L. Zeng, et al., “Core-shell heterojunction of silicon nanowire arrays and carbon quantum dots for photovoltaic devices and self-driven photodetectors”, *ACS Nano*, 8, 4015–4022, (2014)

**Acknowledgements:** This work was partially supported by the European Union’s Horizon 2020 Research and Innovation Programme under the project RADICAL, Grant Agreement No. 899282. The HZDR Ion Beam Centre (IBC) and Nanofabrication Facilities Rossendorf (NanoFaRo) are gratefully acknowledged.

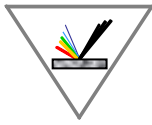

## OP.A1

### IN-SITU ANALYSIS BY STOKES POLARIMETRY AT THE RECORDING BEAM WAVELENGTH OF THE POLARIZATION PROPERTIES OF POLARIZATION HOLOGRAPHIC GRATINGS WITH AND WITHOUT SURFACE RELIEF

L. Nedelchev<sup>1,2</sup>, G. Mateev<sup>1,2</sup>, L. Nikolova<sup>1</sup>, E. Stoykova<sup>1</sup>, D. Nazarova<sup>1,2</sup>

<sup>1</sup>*Institute of Optical Materials and Technologies, Bulgarian Academy of Sciences, Acad. G. Bonchev Str, Bl. 109, 1113 Sofia, Bulgaria*

<sup>2</sup>*University of Chemical Technology and Metallurgy, 8 Kliment Ohridski Blvd, 1756 Sofia, Bulgaria*

*e-mail: [lian\\_n@yahoo.com](mailto:lian_n@yahoo.com)*

It is well known that during polarization holographic recording in azopolymers usually a surface relief grating (SRG) is formed together with the volume anisotropic grating. Here, we present a study on the polarization of the recording beams transmitted through the grating. This is done in real time during the recording process using a novel optical setup including two polarimeters and two power meters. This allows us to obtain detailed information about the influence of the SRG on the polarization properties of the recorded holograms. A simple and yet efficient method is proposed to suppress the SRG formation and thus to improve the polarization properties of the polarization holographic gratings. The feasibility of the method is demonstrated by our experimental results.

**Acknowledgements:** This study is funded by the European Union-NextGenerationEU, through the National Recovery and Resilience Plan of the Republic of Bulgaria, project № BG-RRP-2.004-0002, "BiOrgaMCT". Research equipment of Distributed Research Infrastructure INFRAMAT, part of Bulgarian National Roadmap for Research Infrastructures, supported by Bulgarian Ministry of Education and Science was used in this investigation.

## OP.D1

### TUNABLE PARAMETRIC LIGHT SOURCES FOR APPLICATIONS IN BIOPHYSICS AND MEDICINE

Lyubomir Stoychev<sup>1\*</sup>, Dragomir Vasilev<sup>1,2</sup>, Alexander Parvanov<sup>1,2</sup>, Stephan Shishkov<sup>1,2</sup>, Todor Petrov<sup>1,3</sup>, Ivan Buchvarov<sup>1,2</sup>

<sup>1</sup>*Institute of Solid State Physics, Bulgarian Academy of Sciences, 72 Tsarigradsko Chaussee 1784 Sofia, Bulgaria*

<sup>2</sup>*Faculty of Physics, St. Kliment Ohridski University of Sofia, 5 James Bourchier Blvd., 1164 Sofia, Bulgaria*

<sup>3</sup>*Department of Applied Physics, Faculty of Applied Mathematics and Informatics, Technical University of Sofia, Bulgaria*

*\*e-mail: [stoychev@issp.bas.bg](mailto:stoychev@issp.bas.bg), [lyubomir.stoychev@gmail.com](mailto:lyubomir.stoychev@gmail.com)*

The use of femtosecond and sub-picosecond laser irradiation in Photo Thermal Therapy (PTT) is extremely innovative because these lasers offer rapid temperature rise in tumours, reduced heat diffusion to adjacent tissues, and precise control over the energy delivered to the target. Laser radiation has limited tissue penetration for the most commonly used spectral ranges (NIR-I, 750–1000 nm, 1–2 cm, NIR-II, 1000–1350 nm, > 2 cm) [1], thus tumour cells cannot be

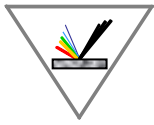

**XXIII International Conference and School on Quantum Electronics:  
“Laser Physics and Applications”**

destroyed. This increases the risk of tumour recurrence and metastasis, limiting the wider clinical PTT application. Therefore, the development of photothermal therapy with less trauma and less postoperative inflammation has become a research hotspot in recent years.

Noble metals such as gold, silver, platinum, and palladium are distinguished by high absorption in the NIR region, high photothermal conversion efficiency, strong local surface plasmon resonance effects, and the ability to regulate their synthesis [2]. These unique properties make them very suitable as photo thermal agents in PTT.

Systematic studies of the influence of subpicosecond laser radiation parameters (wavelength, laser pulse duration, pulse energy, energy/power density), as well as exposure time, on the properties of model lipid and real cellular systems will give us the possibility to determine the most suitable combination for therapeutic applications. These studies are of fundamental importance for the development of the diagnosis and treatment of various diseases - cancer in particular. We focus our work on non-toxic to both lipid and cellular systems nanoparticles, aiming to achieve an optimal concentration of the various additives, which will not violate the integrity of the lipid/cell membranes, nor will they deteriorate their parameters – mechanical stability, elasticity, thermal stability, etc. While all other parameters are readily controlled by the present laser system, we will develop a tunable light source covering the spectral range 300 - 2500 nm based on optical parametric amplification to determine the most suitable wavelength for a specific application on a given physicochemical or biological property (of a model lipid or cell system, respectively). The study of the optimal conditions for generating tunable light at different pulse durations and different repetition rates is presented here.

**References:**

X. He, Sh. Zhang, Yu. Tian, W. Cheng, and H. Jing, “Research Progress of Nanomedicine-Based Mild Photothermal Therapy in Tumor”, *Int. J. Nanomedicine*, 18, 1433-1468, (2023)

A. Bucharskaya, G. Maslyakova, G. Terentyuk, A. Yakunin, Yu. Avetisyan, O. Bibikova, E. Tuchina, B. Khlebtsov, N. Khlebtsov and V. Tuchin, “Towards Effective Photothermal/Photodynamic Treatment Using Plasmonic Gold Nanoparticles”, *Int. J. Mol. Sci.*, 17(8), 1295, (2016)

**OP.C1**

**LASER SYSTEM FOR REMOTE 3D REGISTRATION AND MEASUREMENT OF  
VIBRATION AND TRANSLATIONAL MOVEMENT OF OBJECTS**

Margarita Angelova Deneva, Marin Nenchev Nenchev

*Technical University of Sofia, Plovdiv Branch, Quantum and Optoelectronics Sci. Lab., and  
Optical and Laser Technologies in the Automotive Industry Sci. Lab. at IMEESST,  
25 Tsanko Diustabanov Str, 4000 Plovdiv, Bulgaria*

*e-mail: [mdeneva@yahoo.com](mailto:mdeneva@yahoo.com)*

The work presents a laser interference-wedge-based system for remote optical registration and measurement from distances of meters and hundreds of meters of mechanical vibrations and translations of objects, separately in the three perpendicular directions (3D measurement), namely, horizontally along X, vertically along Y and transversely for the object in the direction of the incident laser beam along Z. The measured vibrations and translations can be with

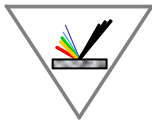

**XXIII International Conference and School on Quantum Electronics:  
“Laser Physics and Applications”**

amplitudes in the ranges of millimeters and centimeters of concrete structures, bridges, subways, buildings, rocks.

The main drawbacks of the known vibration and translation registration and measurement devices are that they operate in direct contact or over short distances of meters, without the ability to determine the 3D components of vibration over long distances (tens and hundreds of meters), and also have the need for connection establishment, mechanical strengthening and protection of cables, difficulties in their displacement, electromagnetic interference. There is no information on purely optical remote systems for 3D vibration measurement from distances of meters, tens and hundreds of meters. There are no known applications in vibrometry of optical devices with interference-wedge structures.

The proposed system for remote 3D registration and measurement of vibrations and translations of objects consists of a suitably formed emitter-receiver unit with an integrated laser source with power supply and laser beam shaper, and a combined unit including three interference wedges (IWs) fixed to the vibrating object. The IWs are implemented as a solid flat plate with typical dimensions as follows: thickness of 1-2 mm, length of 30-50 mm and width of 15-25 mm and micron-scale smoothness. Using cathode sputtering, the following elements are deposited sequentially with these typical parameters – a reflecting (93-97)% mirror, a transparent wedge layer with a thickness of (2-3)  $\mu\text{m}$  and an angle at the apex of  $(1-5)\times 10^{-5}$  rad and a second dielectric mirror with reflection (93-97)%. When illuminated by monochromatic laser light, narrow (1-2) mm resonant transmission lines are formed in the IW (dark in the reflected light) and spaced apart depending on the thickness and angle of the separating layer. The dark lines in the spot are registered without any undesirable diffraction phenomena.

The system allows 3D registration of non-vibrational translation displacement of the object under expansion by heating and by mechanical effects. Visualization of the translation at typical high frequencies is achieved well with an optical receiver and a suitable oscilloscope.

**Acknowledgements:** The authors would like to thank the Competence Center "Intelligent mechatronic, eco- and energy-saving systems and technologies" IMEESST, Contract No BG05M2OP001-1.002-0023-C01, Lab. C8-4 "Optical and laser technologies in the automotive industry" and Sci. Lab. QOEL for the opportunities to perform the experiments of our project, as well as the Research and Development Sector at the Technical University of Sofia for the financial support.

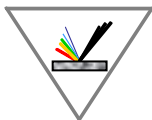

## OP.F2

### PRELIMINARY STUDY OF THE REACTIVITY OF A PRIMAL CARBON CLUSTER TOWARDS AMMONIA IN SPACE

D. A. Kalchevski<sup>1</sup>, D. V. Trifonov<sup>1</sup>, S. K. Kolev<sup>1</sup>, V. N. Popov<sup>2</sup>, H. A. Aleksandrov<sup>3</sup> and T. I. Milenov<sup>1</sup>

<sup>1</sup>*Acad. E. Djakov Institute of Electronics, Bulgarian Academy of Science,  
72 Tsarigradsko Chaussee Blvd, 1784 Sofia, Bulgaria*

<sup>2</sup>*Faculty of Physics, University of Sofia, 5 J. Bourchier Blvd, 1164 Sofia, Bulgaria*

<sup>3</sup>*Faculty of Chemistry and Pharmacy, University of Sofia, 1, James Bourchier Blvd,  
1126 Sofia, Bulgaria*

*e-mail: [dobromirak@ie.bas.bg](mailto:dobromirak@ie.bas.bg)*

The present study is a model of the reactivity between a primal carbon cluster and ammonia in space. The initial processes are simulated with tight-binding dynamics. Metadynamics is employed for the final amination. Characterization of the reactions includes barriers, topology and changes in the electronic structure. The transition state structures were found. The guided processes were found to occasionally induce unbiased structural changes. Simulations of ammonia additions include only the first non-barrierless reaction. The final amination has a forward free energy barrier of an order of magnitude larger than the reverse barrier. The chemical changes yield both quaternary ammonium groups and primary amino groups. The final product is  $C_{25}H_2(NH_3)_2(NH_2)_2$ .

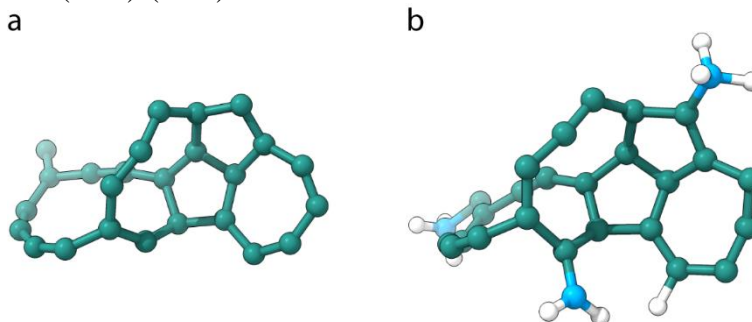
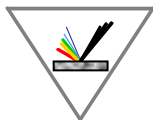

Figure 1. (a) original cluster geometry and (b) geometry of the product after initial amination.

#### References:

[1] D. Kalchevski, D. Trifonov, S. Kolev, V. Popov, H. Aleksandrov, T. Milenov, “A theoretical study on the mechanisms of formation of primal carbon clusters and nanoparticles in space”, arXiv:2404.00096, (2024)

**Acknowledgements:** This study is financially supported by the Bulgarian National Science Fund by grant KP-06-COST/10 (2023) in the framework of the COST Action CA21126-“Carbon molecular nanostructures in space (NanoSpace)”.



## OP.F3

### INITIAL RESULTS ON THE MECHANISM OF CARBONIZATION OF {001} Si-SUBSTRATE AT HIGH TEMPERATURE

Stefan K. Kolev<sup>1</sup>, Dobromir A. Kalchevski<sup>1\*</sup>, Dimitar V. Trifonov<sup>1</sup>, Hristiyan A. Aleksandrov<sup>2</sup>, Teodor I. Milenov<sup>1</sup>

<sup>1</sup>*Acad. E. Djakov Institute of Electronics, Bulgarian Academy of Sciences, 72 Tsarigradsko Chaussee Blvd, 1784 Sofia, Bulgaria*

<sup>2</sup>*Faculty of Chemistry and Pharmacy, University of Sofia, 1 J. Bourchier Blvd, 1164 Sofia, Bulgaria*

*e-mail: [skkolev@ie.bas.bg](mailto:skkolev@ie.bas.bg)*

In this research, Fig. 1, the chemical vapor deposition (CVD) process involving the carbonization of {001} silicon surfaces at a temperature of 1423 K was simulated using quantum metadynamics. The complete sequence of reactions was elucidated, encompassing the creation of an initial SiC crystalline nucleus containing three carbon atoms, occurring alongside native oxide. The analysis of this mechanism encompassed identifying intermediate products and transition states (TSs). The overall free energy landscape of the reaction sequence was determined. Carbonization commences with the formation of alkylated surface products and proceeds with hydrogen elimination. Carbon becomes incorporated into the crystal structure only after all covalent interactions with hydrogen are severed. Notably, the presence of native oxide does not hinder the carbonization process. Oxygen atoms exhibit a degree of surface mobility at the elevated temperature. It was observed that hypervalency of carbon is feasible within the transition states. The rate-limiting step in the CVD synthesis of SiC was identified to have an activation free energy of 166 kJ/mol.

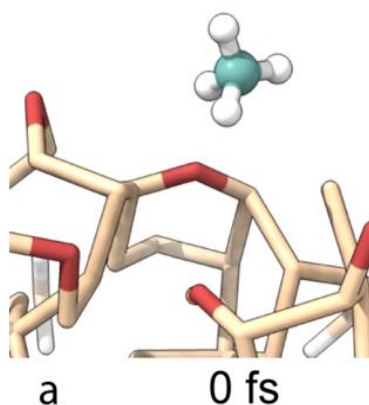
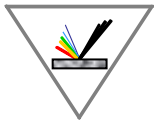

Figure 1. Initial state of the system. Methane molecule is situated above the Si(O) surface.

#### References:

[1] D. Kalchevski, D. Trifonov, S. Kolev, H. Aleksandrov, T. Milenov, “Ab initio study of the mechanism of carbonization of {111} Si-substrate at high temperature”, *Mat. Chem. Phys.*, 317, 129180, (2024)

**Acknowledgements:** The authors gratefully acknowledge financial support from the National Science Fund of Bulgaria under Grant KP-06-H58/2-16.11.2021.



**ORAL PRESENTATIONS – Session II**

**OP.E1**

**NEW LASER METHOD FOR INITIATING NUCLEAR REACTIONS IN THE  
DECAY OF HELIUM NUCLEI TO NUCLEI OF HELIUM ISOTOPES**

E. Iordanova<sup>1</sup>, G. Yankov<sup>1</sup>, I. P. Angelov<sup>2</sup>, L. M. Kovachev<sup>2</sup>

<sup>1</sup>*Institute of Solid State Physics, Bulgarian Academy of Sciences, 72 Tsarigradsko Chaussee,  
1784 Sofia, Bulgaria*

<sup>2</sup>*Institute of Electronics, Bulgarian Academy of Sciences, 72 Tsarigradsko Chaussee,  
1784 Sofia, Bulgaria*

*e-mail: [ekiordanova@gmail.com](mailto:ekiordanova@gmail.com)*

In a few recent papers, a new physical mechanism was suggested for trapping neutral atoms, molecules and particles into the envelopes of femtosecond laser pulses [1-3]. This mechanism allows light atoms, such as hydrogen and helium, to be accelerated up to the group velocity of the pulse. The accelerated neutral atoms admit energies in the range up to 1-2 GeV. In this presentation, we will show how the nuclei of the accelerated helium atoms can be trapped by an external electric field on the cathode of a cylindrical condenser. Since the kinetic energy of the impact of the nuclei on the cathode (~1.8 GeV) is two orders of magnitude greater than the binding energy of the nucleons in the alpha particle (28 MeV), this leads to two decay channels of the alpha particle: to nuclei isotope He<sup>3</sup> with neutron emission or to two deuterium nuclei with intense gamma radiation. On the other hand, the Coulomb repulsion of the helium nuclei isotopes or deuterium nuclei, trapped on the cathode, is greatly reduced, and secondary fusion reactions are possible along several fusion channels [4].

**References:**

[1] Patent application of L. M. Kovachev, E. Iordanova, and G. Yankov, Application N: BG/P/2023/113628: “Method and system for trapping, cooling and compression of neutral atoms, molecules and particles with laser pulses”, (2023)

[2] L.M. Kovachev, “Radiation forces and confinement of neutral particles into the pulse envelope. New regime of collision ionization”, *Optik*, 269, 169943, (2022)

[3] G. Yankov, E. Iordanova, L.M. Kovachev, “Radiation forces and compression of neutral particles by an optical lens”, *Optik*, 273, 170452, (2023)

[4] Patent application of L. M. Kovachev, E. Iordanova, I. P. Angelov and G. Yankov, Application N: BG/P/2024/113904: “Method and system for initiating nuclear reactions in the decay of helium nuclei to nuclei of helium isotopes and deuterium nuclei and subsequent nuclear fusion reactions with application to a laser fusion reactor”, (2024)

**Acknowledgements:** The present work is funded by Bulgarian National Science Fund by Grant No KP-06-H58/8-2021 and The National Roadmap for Research Infrastructure, Bulgaria, “Extreme Light” ELI-ERIC Consortium under contract D01-351/13.12.2023.

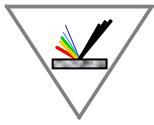

## OP.E2

### IMPACT OF IMPERFECT SURFACE OF COMPRESSOR DIFFRACTION GRATINGS ON THE FOCAL INTENSITY OF A FEMTOSECOND LASER PULSE

Efim Khazanov

*A.V. Gaponov-Grekhov Institute of Applied Physics of the Russian Academy of Sciences,  
46 Ulyanov Str, N. Novgorod, Russia*

*e-mail: [efimkhazanov@gmail.com](mailto:efimkhazanov@gmail.com)*

To reach maximum focal intensity, the laser radiation should be Fourier-limited not only in time, but also in space. For this purpose, acousto-optic programmable dispersive filters and adaptive mirrors are used. However, these technologies cannot compensate for space-time coupling in principle. Since diffraction gratings are not perfectly planned, any compressor inevitably introduces space-time coupling phase distortions, which reduce the focal intensity. This reduction has been numerically studied in many works, for example [1], for specific compressor parameters, but we are not aware of any analytical results

In this work, the focal intensity is found analytically. An expression is obtained in the most general form for an arbitrary compressor – an asymmetric out-of-plane compressor with gratings of arbitrary surface shape. The focal intensity is most strongly affected by the linear angular chirp caused by the spatial shift of different frequencies on the second and third gratings. The second effect is that the shape of the wave front reflected from the grating repeats the shape of the grating, but the proportionality coefficient is frequency dependent.

To the best of our knowledge, studies on this effect have not been reported in the literature before. In addition, a simple method of compensating for space-time coupling is proposed, which consists of two-angle adjusting of the fourth grating, which allows us to significantly increase the focal intensity and/or reduce the requirements for the accuracy of grating manufacturing. The focal intensity of the compressor for the XCELS Project is shown in Fig. 1.

It is shown that the decrease in the focal intensity depends on the product of the grating surface rms  $\sigma$  and the spectrum bandwidth  $\Delta\omega$ . For a given value of  $\sigma$ , with increasing  $\Delta\omega$ , the focal intensity changes in two ways: it increases in proportion to  $1/\Delta\omega$  due to the shortening of the Fourier-limited pulse, but decreases due to an increase in space-time coupling. As a result, a decrease in  $\Delta\omega$  may not reduce the focal intensity, it may even lead to its slight increase.

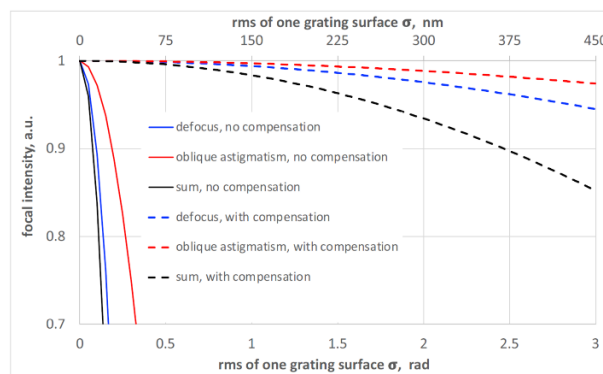
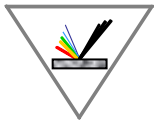

Figure 1: Focal intensity without (solid line) and with (dashed line) compensation for the grating shaped as defocus or vertical astigmatism (blue), oblique astigmatism (red) and the sum of three Zernike polynomials (black).





**XXIII International Conference and School on Quantum Electronics:  
“Laser Physics and Applications”**

**References:**

[1] Z. Li, J. Liu, Y. Xu, Y. Leng, R. Li, “Simulating spatiotemporal dynamics of ultra-intense ultrashort lasers through imperfect grating compressors”, *Optics Express*, 30, 41296-41312, (2022)

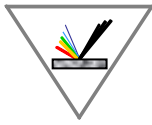

**ORAL PRESENTATIONS – Session III**

**OP.F4**

**2D MoS<sub>2</sub> SYNTHESIS PROCESS ENHANCEMENT USING MIXED PRECURSORS**

Blagovest Napoleonov<sup>1</sup>, Vladimira Videva<sup>1,2</sup>, Nikolay Minev<sup>1</sup>, Dimitre Dimitrov<sup>1,3</sup>  
Vera Marinova<sup>1</sup>

<sup>1</sup>*Institute of Optical Materials and Technologies, Bulgarian Academy of Sciences,  
1113 Sofia, Bulgaria*

<sup>2</sup>*Faculty of Chemistry and Pharmacy, Sofia University, 1 James Bourchier Blvd.,  
1164 Sofia, Bulgaria*

<sup>3</sup>*Institute of Solid State Physics, Bulgarian Academy of Sciences, 72 Tsarigradsko  
Chaussee, 1784 Sofia, Bulgaria*

*email: [bnapoleonov@iomt.bas.bg](mailto:bnapoleonov@iomt.bas.bg)*

The synthesis of high-quality two-dimensional molybdenum disulfide (MoS<sub>2</sub>) is a crucial step in achieving novel applications in nanoelectronics and optoelectronics. This study introduces an innovative *c*-cut sapphire pre-treatment strategy using sodium sulfide (Na<sub>2</sub>S) to enhance the MoS<sub>2</sub> growth. In this method, the substrate is dipped in a  $2 \times 10^{-2}$  M deionized water solution of Na<sub>2</sub>S, which facilitates the release of hydrogen sulfide (H<sub>2</sub>S) through a reaction with atmospheric moisture. The H<sub>2</sub>S generated *in situ* acts as an effective catalyst for the growth of MoS<sub>2</sub> monolayers, offering a viable alternative to the conventional Ar/H<sub>2</sub> gas mixture used in many synthesis protocols. This approach significantly improves the quality, uniformity, and growth rate of MoS<sub>2</sub> layers, as confirmed by XPS, AFM, and Raman analysis, and simplifies the synthesis process by eliminating the need for complex gas-flow systems. The results demonstrate that this Na<sub>2</sub>S pre-treatment method is both cost-effective and scalable, presenting a promising solution for the efficient and sustainable production of MoS<sub>2</sub> for future technological applications.

**References:**

[1] H. Yao, L. Liu, Z. Wang, H. Li, L. Chen, M.E. Pam, W. Chen, H.Y. Yang, W. Zhang, Y. Shi, “Significant photoluminescence enhancement in WS<sub>2</sub> monolayers through Na<sub>2</sub>S treatment”, *Nanoscale*, 10(13), 6105-6112, (2018)

**Acknowledgements:** This work is supported by the Bulgarian National Science Fund by grant number KP-06-COST/15 under COST CA 20116 Action “European Network for Innovative and Advanced Epitaxy” (OPERA). Financial support is also acknowledged from the research equipment of distributed research infrastructure INFRAMAT (part of the Bulgarian National roadmap for research infrastructures) supported by the Bulgarian Ministry of Education and Science.

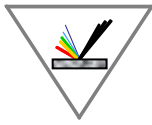

## OP.B1

### DFT SIMULATION OF BILAYER GRAPHENE RAMAN SPECTRUM

Dimitar V. Trifonov<sup>1\*</sup>, Dobromir A. Kalchevski<sup>1</sup>, Stefan K. Kolev<sup>1</sup>, Valentin N. Popov<sup>3</sup>,  
Hristiyan A. Aleksandrov<sup>2</sup> and Teodor I. Milenov<sup>1</sup>

<sup>1</sup>*E. Djakov Institute of Electronics, Bulgarian Academy of Sciences, 72 Tsarigradsko  
Chaussee Blvd., 1784 Sofia, Bulgaria*

<sup>2</sup>*Faculty of Chemistry and Pharmacy, University of Sofia, 1 J. Bourchier Blvd.,  
1164 Sofia, Bulgaria*

<sup>3</sup>*Faculty of Physics, University of Sofia, 5 J. Bourchier Blvd., 1164 Sofia, Bulgaria*

*e-mail: [dtrifonov@ie.bas.bg](mailto:dtrifonov@ie.bas.bg)*

Nowadays Raman spectroscopy is an indispensable analytical tool in graphene research. In our recent publication [1], we demonstrate that the Raman spectra of perfect graphene and single-layer graphene with point defects (single carbon atoms in sp<sup>3</sup> hybridization) simulated by computational methods such as DFT qualitatively match the experimental data. Here we present the results of DFT simulations of the Raman spectrum of bilayer graphene (perfect and with some structural defects).

#### References:

[1] S. K. Kolev et al. “DFT simulation of the Raman spectrum of single layer graphene”, J. Phys.: Conf. Ser., 2487, 012003, (2023)

**Acknowledgements:** The authors gratefully acknowledge the financial support of the Bulgarian National Science Fund under grant KP-06-H58/2 – 16.11.2021.

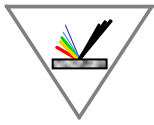

**ORAL PRESENTATIONS – Session IV**

**OP.E3**

**COMPARISON OF PRISM COMPENSATED FS PULSE PARAMETERS USING SPIDER, GRENOUILLE AND INTERFEROMETRIC AUTOCORRELATION**

M. Zhekova, N. Dimitrov, N. Kazlachev, A. Dreischuh

*Department of Quantum Electronics, Faculty of Physics, University of Sofia,  
5 J. Bourchier Blvd., Sofia, Bulgaria*

*e-mail: [maya.zhekova@gmail.com](mailto:maya.zhekova@gmail.com)*

Ultrashort (femtosecond and recently attosecond) pulses are among the hardest to analyze in terms of pulse duration and shape since the response times of standard measuring devices are too slow. For the last decades with the increased interest in this field a number of techniques have been developed, like FROG/GRENOUILLE, SPIDER and interferometric autocorrelation (IA).

Dispersion gain is usually compensated with a dispersion element – a set of two prisms with a reflective element (mostly used inside the resonator) or chirped mirrors (both in and out of the resonator). In both cases, these elements compensate the natural dispersion of the pulse. A measurement of a femtosecond pulse using these three techniques was conducted, altering the compressor properties (prism penetration) which changes the pulse duration, group velocity dispersion, group delay dispersion, third order dispersion, a slight shift in the central wavelength and bandwidth (Fig 1). Comparing the results with the theoretical model [1,2] we were able to confirm the behavior of the listed parameters. Additionally, we were able to see a slight mismatch between GRENOUILLE and SPIDER/IA measurements, which will require further investigation.

Using 16 chirped reflections from 8 chirped mirrors (Fig. 2) between the oscillator and the analyzing elements we were able to compare the elongation of the pulse [3] with and without them and additionally measure GDD (given by specifications) and TOD, which was not given by the manufacturer and was successfully measured.

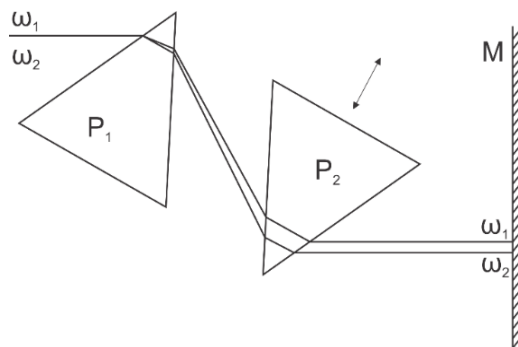

Figure 1. Prism Compressor.

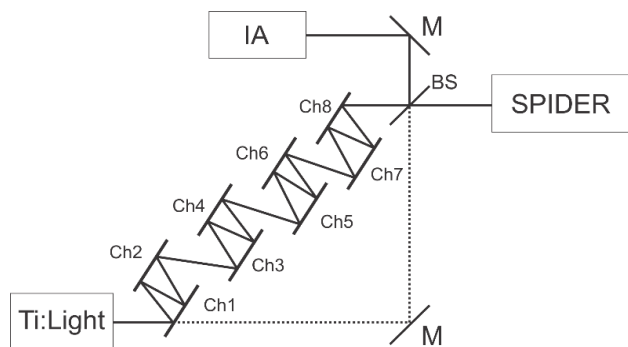
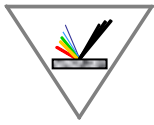

Figure 2. Scheme of "chirped" and "unchirped" pulse.

**References:**

- [1] Z. Zhang, T. Yagi, “Observation of group delay dispersion as a function of the pulse width in a mode locked Ti: sapphire laser”, Appl. Phys. Lett., 63, 22, 2993–2995, (1993)
- [2] R.L. Fork, O.E. Martinez, J.P. Gordon “Negative dispersion using pairs of prisms”, Optics Letters, 9(5), 150–152, (1984)



[3] R. Szipocs, K. Ferencz, C. Spielmann, F. Krausz “Chirped multilayer coatings for broadband dispersion control in femtosecond lasers”, *Optics Letters*, 19(3), 201–203, (1994)

**Acknowledgements:** This work was supported by projects 80-10-17/8.4.2024 and KP-06-N78/6-05.12.2023.

## OP.E4

### NECKLACE TO SECOND-HARMONIC QUASI-NON-DIFFRACTING BEAM CONVERSION

N. Dimitrov, K. Christov, M. Zhekova, A. Dreischuh

*Faculty of Physics, St. Kliment Ohridski University of Sofia, 5 J. Bourchier Blvd.,  
1164 Sofia, Bulgaria*

*e-mail: [nrd@phys.uni-sofia.bg](mailto:nrd@phys.uni-sofia.bg)*

In this work, we study the formation of quasi-non-diffracting beams from singular beams when using a second-order nonlinear process. The idea is based on the fact that when a light beam carrying  $\pi$ -phase dislocation generates its second harmonic (SH) for the frequency doubled field that “jump” is equal to  $2\pi$ . In other words, the even-order nonlinear process could be used to “erase”  $\pi$ -phase singularities. Here, by interference of optical vortices, we obtain the so-called “necklace” beam [1] (see left panel in Fig. 1), in which azimuthal  $\pi$ -phase steps separate the bright spots. Focusing that formation will cause only a scaling of the transverse intensity profile pattern. However, if an SH crystal is placed just before the focal plane, the newly generated light will have “smooth” concave phase profile composed by bright spots that will further diffract to form a bright ring. Therefore, after the focal plane, in the SH we will obtain a Bessel-Gaussian beam [2]. Theoretical and experimental results confirming this evolution scenario will be discussed in detail.

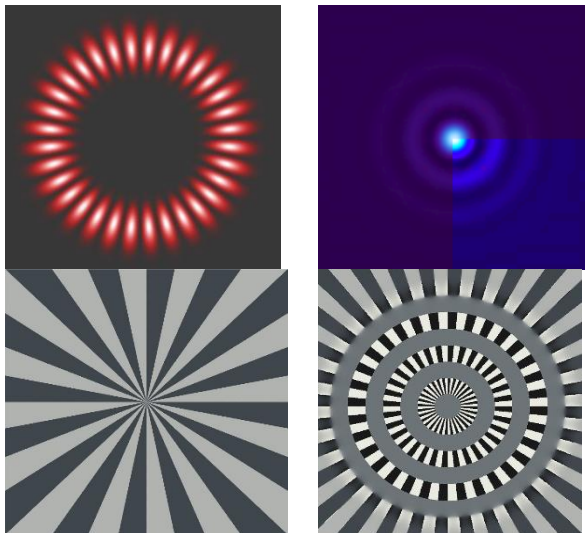
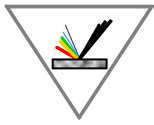

**Figure 1.** Theoretically simulated beam profiles: **Left column** – Initial necklace beam: intensity (upper frame) and phase profiles (bottom frame); **Right column** – Obtained quasi-non-diffracting SH beam: intensity and phase profiles (top/bottom, respectively). Please note that in the phase profiles shown in the respective bottom frames black, grey, and white denote phases  $0$ ,  $\pi$ , and  $2\pi$ . Hence, the input necklace beam (left column) has azimuthal  $\pi$ -phase dislocations while the generated Bessel-Gaussian beam (right column) is carrying radial phase dislocations between its coaxial rings, typical for a Bessel-Gaussian beam.

#### References:

[1] N. Dimitrov, M. Zhekova, Y. Zhang, G. G. Paulus, and A. Dreischuh, “Background-free femtosecond autocorrelation in collinearly-aligned inverted field geometry using optical vortices”, *Optics Communications*, 504, 127493, (2022)

[2] L. Stoyanov, M. Zhekova, A. Stefanov, B. Ivanov, I. Stefanov, G. G. Paulus, and



A. Dreischuh, “Generation of long range low-divergent Gauss–Bessel beams by annihilating optical vortices”, Optics Communications, 480, 126510, (2021)

**Acknowledgements:** We acknowledge funding by the Bulgarian Ministry of Education and Science as a part of the National Roadmap for Research Infrastructure (DO1-351/13.12.2024) and by the Scientific Fund of Sofia University (80-10-17/8.4.2024).

## OP.B2

### EXPERIMENTAL INVESTIGATION OF CESIUM D<sub>2</sub> LINE MAGNETO-OPTICAL RESONANCES IN 1-D CONFINED ATOMIC VAPOR WITH MICROMETRIC THICKNESS

P. Todorov, N. Petrov, E. Taskova

*Academician Emil Djakov Institute of Electronics, Bulgarian Academy of Sciences,  
72 Tsarigradsko Chaussee., 1784 Sofia, Bulgaria*

*e-mail: [p\\_todorov@ie.bas.bg](mailto:p_todorov@ie.bas.bg)*

The interaction of coherently-prepared atomic media with a coherent light field revealed many areas of research and applications. Phenomena like coherent population trapping (CPT), electromagnetically induced transparency (EIT), electromagnetically induced absorption (EIA), sub-recoil laser cooling, slow light, optical magnetometers, CPT based atomic clocks and compact frequency references are the most important examples. When one obtains a CPT resonance by coherent pumping of a degenerate hyperfine transition with a fixed-frequency laser radiation and scanning the magnetic field (Hanle configuration), one distinguishes between two types of effects defined in the transmitted laser field – EIT and EIA [1]. It has been shown theoretically and experimentally that for cm-size vapor cells if  $F_g \geq F_e$  one obtains an EIT resonance, or a dark resonance [1, 2] while for  $F_g < F_e$ , an EIA resonance is observed [1, 3].  $F_g$  and  $F_e$  are the quantum numbers of the hyperfine energy levels corresponding to the total atomic angular momentum. For an extremely thin cell (ETC) with a thickness below 10 micrometers, only dark resonances are present at the resonance transition center due to the frequent depolarizing collisions with the cell walls [4]. Although many theoretical studies for CPT resonances have been performed in the intermediate range of cell thickness between 10 micrometers to 1 mm, or thin cells (TC), the experimental investigations in the thickness range below 100 micrometers remain few.

In this communication, we report on an experimental study of magneto-optical resonances in cesium D<sub>2</sub> line in a Hanle-type configuration for propagation longitudinal to the laser field, scanning magnetic field and linear light polarization. The study is performed in a thin spectroscopic cell with uniform thickness of 19 micrometers. The TC is not shielded against the laboratory stray magnetic field environment. We explore the six hyperfine transitions allowed in dipole approximation in transmitted through the cell laser intensity in terms of the transition amplitude, width, shift and contrast. We also measure the dependence of these spectral parameters from an atomic concentration and laser light intensity.

#### References:

[1] Y. Dancheva, G. Alzetta, S. Cartaleva, M. Taslakov and Ch. Andreeva, “Coherent effects on the Zeeman sublevels of hyperfine states in optical pumping of Rb by monomode diode laser”, Opt. Commun., 178, 103, (2000)

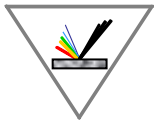

[2] F. Renzoni, W. Maichen, L. Windholz and E. Arimondo, “Coherent population trapping with losses observed on the Hanle effect of the D 1 sodium line”, Phys. Rev. A, 55, 3710, (1997)

[3] F. Renzoni, C. Zimmermann, P. Verkerk and E. Arimondo, “Enhanced absorption Hanle effect on the  $F_g = F \rightarrow F_e = F + 1$  closed transitions”, J. Opt. B: Quantum Semiclassical Opt., 3, (2001)

[4] C. Andreeva, A. Atvars, M. Auzinsh, K. Blush, S. Cartaleva, L. Petrov and D. Slavov, “Ground-state magneto-optical resonances in cesium vapor confined in an extremely thin cell”, Phys. Rev. A, 76, 063804, (2007)

## OP.D2

### SPECTRAL PROPERTIES OF COLLAGEN MODIFICATIONS AND THEIR APPLICATION FOR DIAGNOSTICS

Ts. Genova<sup>1</sup>, Al. Zhelyazkova<sup>1</sup>, L. Zaharieva<sup>1</sup>, I. Angelov<sup>1</sup>

<sup>1</sup>*Institute of Electronics, Bulgarian Academy of Sciences, 72 Tsarigradsko Chaussee Blvd.,  
1784 Sofia, Bulgaria*

*e-mail: [ts.genova@gmail.com](mailto:ts.genova@gmail.com)*

Collagen is one of the main structural proteins in the extracellular matrix. However, its role is not only as a building element in different types of tissues, but also as a signaling molecule, which takes part in regulating processes defining the cellular shape, behavior, even differentiation. Specific alterations of the collagen fluorescence have been observed for abnormal tissues in comparison with healthy tissues; its potential as a diagnostic marker has been thus recognized.

This work is dedicated to gaining a better understanding of the specific alterations in collagen fluorescence in view of recognizing them in tissue fluorescence, which originate from multiple overlapping fluorophores. We performed an investigation of the spectral properties of collagen in different modifications, namely, powdered collagen, hydrogel, thin layers, thick layers and diagnostically valuable collagen compounds. The results were compared with the spectral properties of skin and gastrointestinal pathologies.

**Acknowledgements:** The investigations were supported by the Bulgarian National Science Fund under grants #KP-06-N38/13/2019 and by the Ministry of Education and Science NRRI 2020-2027 funding agreement #D01-352/13.12.2023 “National Centre of Biomedical Photonics”.

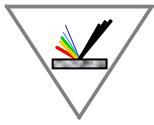

**XXIII International Conference and School on Quantum Electronics:  
“Laser Physics and Applications”**

**POSTER SESSIONS  
PRESENTED CONTRIBUTIONS**



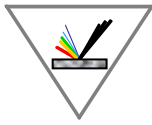

---

**POSTER SESSIONS**

**POSTER SESSION I**

**P.A1**

**POLARIZATION GRATINGS RECORDED IN AZOPOLYMER THIN FILMS BY  
DIGITAL POLARIZATION HOLOGRAPHY**

Nataliya Berberova-Buhova<sup>1,2</sup>, Lian Nedelchev<sup>1,2</sup>, Georgi Mateev<sup>1,2</sup>, Branimir Ivanov<sup>1</sup>,  
Ludmila Nikolova<sup>1</sup>, Blaga Blagoeva<sup>1</sup>, Elena Stoykova<sup>1</sup>, Dimana Nazarova<sup>1,2</sup>

<sup>1</sup>*Institute of Optical Materials and Technologies, Bulgarian Academy of Sciences,  
1113 Sofia, Bulgaria*

<sup>2</sup>*University of Chemical Technology and Metallurgy, 8 St. Kliment Ohridski Blvd,  
1756 Sofia, Bulgaria*

*email: [nataliyabuhova2016@gmail.com](mailto:nataliyabuhova2016@gmail.com)*

Polarization diffraction gratings with various profiles were generated in order to be used with a reflective phase spatial light modulator (SLM). Using a digital polarization holographic setup including the SLM and two quarter-wave plates, the spatial modulation of polarization was recorded on thin films of the azopolymer PAZO (poly[1-[4-(3-carboxy-4-hydroxyphenylazo)benzene sulfonamido]-1,2-ethanediyl, sodium salt]). One-dimensional and two-dimensional polarization gratings with different profiles parameters were recorded and the kinetics during recording in diffraction orders were obtained in real time. The obtained polarization diffraction gratings were analyzed by atomic force microscopy and by polarization optical microscopy.

**Acknowledgements:** The authors are grateful for the funding from the Bulgarian National Science Fund (BNSF) through project KII-06-KOCT/19. This work was supported by the funding from the European Union–Next Generation EU, through the National Recovery and Resilience Plan of the Republic of Bulgaria, project BG-RRP-2.004-0002, “BiOrgaMCT”. Research equipment of Distributed Research Infrastructure INFRAMAT, part of the Bulgarian National Roadmap for Research Infrastructures, supported by the Bulgarian Ministry of Education and Science, was used in this investigation.

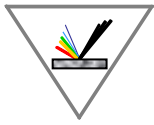

## P.A2

### POLARIZATION HOLOGRAPHIC GRATINGS IN PHOTOANISOTROPIC MATERIALS DOPED WITH METALLIC AND METALLIC COMPLEXES NANOPARTICLES

D. Nazarova<sup>1,2,\*</sup>, N. Berberova-Buhova<sup>1,2\*</sup>, G. Mateev<sup>1,2</sup>, A. Stoilova<sup>1,2</sup>, D. Dimov<sup>1,2</sup>,  
E. Stoykova<sup>1</sup>, Keehoon Hong<sup>3</sup> and L. Nedelchev<sup>1,2</sup>

<sup>1</sup>*Institute of Optical Materials and Technologies, Bulgarian Academy of Sciences,  
1113 Sofia, Bulgaria*

<sup>2</sup>*Department of Physics, University of Chemical Technology and Metallurgy, 8 St. Kliment  
Ohridski Blvd, 1756 Sofia, Bulgaria*

<sup>3</sup>*Electronics and Telecommunications Research Institute, 218 Gajeong-ro, Yuseong-gu,  
Daejeon 34129, Republic of Korea*

\*Correspondence: [dimanain@gmail.com](mailto:dimanain@gmail.com); [nataliyabuhova2016@gmail.com](mailto:nataliyabuhova2016@gmail.com)

Photoanisotropic materials have attracted significant research interest in the last decades due to their applications in polarization holography, polarization-selective diffractive optical elements with unique properties and many others. New methods have been investigated to increase the photoinduced birefringence of these materials in order to obtain high-efficiency polarization holographic elements. One such approach is being extensively studied, namely, doping azobenzene-containing materials with nanoparticles with various compositions, sizes, and morphologies. The paper presents a study of the diffraction efficiency and surface relief comparison of polarization holographic gratings recorded in nanocomposite thin films of the azopolymer PAZO (poly[1-[4-(3-carboxy-4-hydroxyphenylazo) benzenesulfonamido]-1,2-ethanediyl, sodium salt]) doped with different metallic nanoparticles: gold (Au), Cu(II) 3-amino-5,5'-dimethylhydantoin (CLP) and Ni(II) 3-amino-5,5'-dimethylhydantoin (NLP) at optimal concentrations. The gratings are recorded at a 442-nm wavelength by a He-Cd gas laser. The polarization used of the two recording beams was left and right circular. Along with the anisotropic grating in the volume of the media, a surface relief was also formed. The influence is discussed of the dopants' composition and concentration on the parameters of the polarization holographic gratings recorded in the thin composite films. The diffraction efficiency kinetics was probed at 635 nm and the height of the relief gratings was determined by AFM. A diffraction efficiency ( $\eta$ ) higher than 30% was achieved for the hybrid samples, as well as a surface relief height higher than 550 nm.

**Acknowledgements:** This work was supported by the Institute of Information & Communications Technology Planning & Evaluation (IITP), grant No. 2019-0-00001. The authors are grateful for the funding from the European Union–Next Generation EU, through the National Recovery and Resilience Plan of the Republic of Bulgaria, project BG-RRP-2.004-0002, “BiOrga MCT”. The authors gratefully acknowledge the support provided by the Bulgarian National Science Fund (BNSF) through project KII-06-KOCT/19. Research equipment of Distributed Research Infrastructure INFRAMAT, part of the Bulgarian National Roadmap for Research Infrastructures, supported by the Bulgarian Ministry of Education and Science, was used in this investigation.

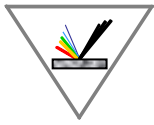

## P.A3

### SUPERFICIAL STRUCTURING OF COPPER BY FEMTOSECOND LASER RADIATION FOR DEVELOPMENT OF ANTIBACTERIAL SURFACES

Emil Filipov<sup>1\*</sup>, Liliya Angelova<sup>1</sup>, Ina Erceg<sup>2</sup>, Albena Daskalova<sup>1</sup>

<sup>1</sup>*Institute of Electronics, Bulgarian Academy of Sciences, 72 Tsarigradsko Chaussee Blvd, 1784 Sofia, Bulgaria*

<sup>2</sup>*Correlative Microscopy and Materials Data, Fraunhofer Institute for Ceramic Technologies and Systems IKTS, Äußere Nürnberger Str. 62, 91301 Forchheim, Germany*

email: [efilipov@ie.bas.bg](mailto:efilipov@ie.bas.bg); [emil.filipov95@gmail.com](mailto:emil.filipov95@gmail.com)

Surfaces that are under highly frequent contact at public places, such as door handles or buttons in hospitals, can retain microbes, thus facilitating the spread of infections among people [1]. The inability of constant sterilization of such surfaces and the lack of people's habit to sanitize often their hands require the need of developing novel antimicrobial surfaces that endure the constant contact and reduce the microbial load. A potent strategy for overcoming this problem is creating superficial structures that could physically hinder the microbial adhesion, thus decreasing the microbial retention. Such structures can be realized by femtosecond laser radiation, which allows modeling of a material's surface at a micro- or nanoscale without compromising its mechanical properties while controlling its physicochemical ones.

This preliminary research investigates the application of femtosecond laser ablation ( $\lambda = 800$  nm;  $\tau = 70$  fs) with varying working parameters for development of combined crossed micro- and nano-surface patterns on copper (CW004A, 99.9%). The used range of parameters ( $F = 4.1$  J/cm<sup>2</sup>;  $v = 0.5 - 1$  mm/s) led to the formation of crossed microgrooves bearing laser induced periodic surface structures (LIPSS), which were visualized by means of scanning electron microscopy (SEM) and confocal microscopy. Energy dispersive X-ray spectroscopy (EDS) was used to monitor the change in surface oxidation in relation to the laser ablation. Since the surface hydrophobicity is a parameter that plays a key role in bacteria-material interaction [2], the level of wettability of the modified copper was investigated via water contact angle measurements. The results indicated that the laser-induced modifications had shifted the wetting state of the copper towards a superhydrophobic one.

The proposed methodology aims at developing sustainable high-touch surfaces exhibiting antimicrobial properties for combating the spread of infections in public places. The use of femtosecond laser structuring led to the formation of hierarchical multiscale structures which strongly increased the hydrophobicity of the material. Due to their morphology and dimensions, the developed patterns could potentially affect the microbial adhesion and reduce the retention of microorganisms to the surface.

#### References:

[1] A. Konno, T. Okubo, Y. Enoda, T. Uno, T. Sato, S. Yokota, R. Yano, H. Yamaguchi, “Human pathogenic bacteria on high-touch dry surfaces can be controlled by warming to human-skin temperature under moderate humidity”, *PLoS ONE*, 18(9), e0291765, (2023)

[2] Y. Yuan, M. P. Hays, P. R. Hardwidge, J. Kim, “Surface characteristics influencing bacterial adhesion to polymeric substrates”, *RSC Adv.*, 7, 14254–61, (2017)

**Acknowledgements:** This work was funded by the European Union: Horizon Europe program under the Grant Agreement № 101057961, „Surface transfer of pathogens” (STOP).

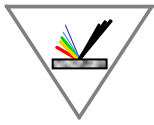

## P.A4

### TUNING THE SURFACE PROPERTIES OF STAINLESS-STEEL THROUGH SYNERGISTIC EFFECT OF LIPSS AND MAGNETRON SPUTTERING

Albena Daskalova<sup>1</sup>, Liliya Angelova<sup>1</sup>, Harleen Kaur<sup>2</sup>, Angela Ivask<sup>2</sup>, Maja Sikiric<sup>3</sup>, Tihomir Car<sup>3</sup>, Qun Ren<sup>4</sup>, Mihyun Lee<sup>4</sup>, Abeer Shaalan<sup>5</sup>, Lucy di Silvio<sup>5</sup>

<sup>1</sup>*Laboratory of Nonlinear and fiber optics, Institute of Electronics, Bulgarian Academy of Sciences, 72 Tsarigradsko Chaussee Blvd, 1784 Sofia, Bulgaria*

<sup>2</sup>*Institute of Molecular and Cell Biology, U Tartu, Riia 23-301, Tartu, Estonia  
RuđerBošković Institute, Bijenicka cesta 54, 10 000 Zagreb, Croatia*

<sup>4</sup>*Empa, Lerchenfeldstrasse 5, 9014 St. Gallen, Switzerland*

<sup>5</sup>*King's College London, Guy's Hospital, Tower Wing, SE1 9RT London, UK*

*e-mail: [albdaskalova@gmail.com](mailto:albdaskalova@gmail.com)*

The global COVID-19 pandemic has turned the attention to the creation of improved antiviral and antimicrobial durable surfaces and coatings. In addition to the direct route for infection transmission (between humans), there exists a possibility of spreading pathogens indirectly by contact with nearby surfaces or items that an infected person has used. In this case, to prevent the transfer of pathogens diverse nanomaterials and nanoparticles have been used in surface coatings to enhance their antibacterial and antiviral behavior. A number of coating methods have been employed to create a pathogen-free surface. It is known that copper (Cu) and silver (Ag) possess a high antimicrobial activity. Thus, in the current studies, magnetron sputtering technique was applied successfully to prepare metallic coatings from Cu and Ag with the aim of enhancing the surface antibacterial properties of stainless steel (a widely used material in public zones). Ultra-short pulse laser-based processing was applied to stainless steel samples prior to deposition of thin films in view of changing the surface morphology by creating nanometric laser-induced surface structures (LIPSS). The characteristics were studied of Ag and Cu thin films deposited by magnetron sputtering on LIPSS morphological structures. The structures as created by the hybrid method were thoroughly examined by SEM, EDS, Raman and WCA analyses; the obtained elemental spectra provided quantitative evaluation of the surface chemical composition. In the case of Cu deposition over LIPSS structures, the presence of oxygen was detected. The results suggest that structural changes of surface and oxygen percentage impact highly the wettability state of the SS sample.

It was concluded that the effect of both methods for creation of nanometric LIPSS structures and the deposition of thin films of antibacterial agents as Ag and Cu may be applied to create a contact-killing surface for an improved protection against bacterial infection.

#### References:

[1] G. Benetti, E. Cavaliere, F. Banfi, L. Gavioli, “Antimicrobial Nanostructured Coatings: A Gas Phase Deposition and Magnetron Sputtering Perspective”, *Materials*, 13, 784, (2020)

[2] D. Medina-Cruz, M. González, W. Tien-Street, M. Fernández-Castro, A. Vernet-Crua, I. Fernández-Martínez, L. Martínez, Y. Huttel, T. J. Webster, J. M. García-Martín, “Synergic antibacterial coatings combining titanium nanocolumns and tellurium nanorods”, *Nanomedicine: Nanotechnology, Biology and Medicine*, 17, 36-46, (2019)

**Acknowledgements:** This work was funded by the European Union, Horizon Europe Program under Grant Agreement No 101057961 “Surface transfer of pathogens” (STOP), and by the Bulgarian Ministry of Education and Science, Grant DO1-351-2023.

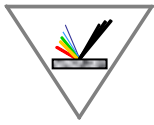

## P.A5

### PHOTOSENSITIVE CHARACTERISTICS OF ZnO AND ZnO-TiO<sub>2</sub> NANOSTRUCTURES PRODUCED BY OPEN-AIR PLD

T. Dilova<sup>1</sup>, A. Og. Dikovska<sup>2</sup>, G. Atanasova<sup>1</sup>, N. N. Nedyalkov<sup>2</sup>

<sup>1</sup>*Institute of General and Inorganic Chemistry, Bulgarian Academy of Sciences,  
Acad. G. Bonchev str, bl. 11, 1113 Sofia, Bulgaria*

<sup>2</sup>*Institute of Electronics, Bulgarian Academy of Sciences, 72 Tsarigradsko Chaussee,  
1784 Sofia, Bulgaria*

*email: [tina@svr.igic.bas.bg](mailto:tina@svr.igic.bas.bg)*

Ultraviolet photodetectors have a wide range of applications in the fields of UV radiation detection, space exploration and environmental monitoring. The high electron mobility and the chemical and thermal stability of ZnO make it a material suitable for the production of photosensitive elements. Various configurations of ZnO-based photodetectors have been produced and characterized by researchers over the years.

In this work, the pulsed laser deposition in air at atmospheric pressure (open-air PLD) method was used to prepare photosensitive elements. It is a practical and relatively inexpensive way of obtaining highly porous nanostructures composed of nanoparticles or nanoaggregates characterized by a large surface-to-volume ratio.

Samples were produced by *ns*- and *ps*-laser ablation of pure ZnO or mixed ZnO-TiO<sub>2</sub> targets on SiO<sub>2</sub> substrates with pre-deposited gold electrodes. The structure, morphology, and composition of the nanostructures obtained were studied in what concerns the sample composition and laser ablation regime applied. The ablation of a mixed ZnO-TiO<sub>2</sub> target led to the fabrication of composite samples consisting of ZnO and Zn<sub>2</sub>TiO<sub>4</sub> nanoparticles. Also, the electrical properties were studied of pure and composite samples under exposure to light (UV, Vis, and IR) irradiation. It was found that the photosensitive properties of the samples depended on the ablation regime applied.

**Acknowledgements:** The authors acknowledge the financial support of project KP-06-M69/7 “Investigation of photosensitivity of metal oxide thin films and nanostructures” under the Program of the National Science Fund, Ministry of Education and Science of Bulgaria.

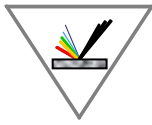

## P.A6

### ULTRA-SHORT-LASER-BASED SUSTAINABLE STRUCTURING OF POLYPROPYLENE SURFACES FOR FREQUENTLY TOUCHED SUPERFICIES

Liliya Angelova<sup>1</sup>, Albena Daskalova<sup>1</sup>, Anna Dikovska<sup>1</sup>

<sup>1</sup>*Institute of Electronics, Bulgarian Academy of Sciences, 72 Tsarigradsko Chaussee Blvd,  
1784 Sofia, Bulgaria*

*e-mail: [lily1986@abv.bg](mailto:lily1986@abv.bg)*

According to the World Health Organization, antibiotic-resistant bacteria are among the serious global societal problems – the diseases such pathogens mediate are becoming an increasing issue in hospitals, kindergartens and public areas, where they are widely proliferating over surfaces. Plastics and polypropylene in particular, along with metals, are the most common basic materials for producing a great variety of frequently touched surfaces, like plastic toys, slides and swings at playgrounds, single use utensils, etc. The traditional surface deposition of chemical compounds for achieving bactericidal action does not provide a long-lasting effect and can even induce adverse effects due to interactions between the substance and the surface material.

Picosecond and femtosecond laser-based surface texturing, on the other hand, possess numerous advantages over other modification techniques. These contactless methods are characterized by high precision and tunability of the applied laser radiation parameters and provide a possibility for diverse micro and nano surface designs. The connection between surface roughness, wettability properties, and bacterial size is essential for bacterial attachment to diverse surfaces – reducing the initial attachment of pathogens to the surface is the key to preventing biofilm formation and bacteria proliferation. Controlling the interplay between wettability and surface roughness is the basis of achieving this goal.

In this study, the influence was investigated of femtosecond and picosecond laser processing parameters on the surface morphology and wettability properties of polypropylene in view of future application in the design of persistent bacteria-free frequently touched surfaces. It was found that the morphology and wettability of the laser-induced surface structures can be efficiently tuned by adapting the laser processing parameters so as to create structures possessing antibacterial properties.

**Acknowledgements:** This work was funded by the European Union: Horizon Europe program under Grant Agreement No 101057961 „Surface transfer of pathogens” (STOP).

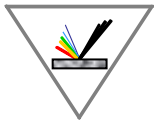

## P.A7

### LASER STRUCTURING OF THIN METAL FILMS

N. N. Nedyalkov<sup>1\*</sup>, P. A. Atanasov<sup>1</sup>, A. O. Dikovska<sup>1</sup>, K. Grochowska<sup>2</sup>, J. Karczewski<sup>3</sup>,  
M. Sawczak<sup>2</sup>, R. Jendrzewski<sup>2</sup>

<sup>1</sup>*Institute of Electronics, Bulgarian Academy of Sciences, 72 Tsarigradsko Chaussee,  
1784 Sofia, Bulgaria*

<sup>2</sup>*The Szewalski Institute of Fluid-Flow Machinery, Polish Academy of Sciences, 14 Fiszer  
Str., 80-231 Gdańsk, Poland*

<sup>3</sup>*Faculty of Applied Physics and Mathematics, Institute of Nanotechnology and Materials  
Engineering, University of Technology, Narutowicza 11/12 Street, 80-233 Gdansk, Poland*

*e-mail: [nned@ie.bas.bg](mailto:nned@ie.bas.bg)*

This work presents results on structuring of thin gold/silver (AuAg) composite film by laser pulses with different pulse durations. Laser systems that generate millisecond (50 ms), nanosecond (15 ns), picosecond (10 ps), and femtosecond (100 fs) pulses are used in the experiments. The laser wavelength is 1064 nm for the ms, ns, and ps regimes and 800 nm for the femtosecond one. The metal films are deposited by pulsed laser deposition on quartz substrates using nanosecond laser pulses. The surface morphology is studied as induced by a variety of processing parameters – pulse duration, applied laser fluence and number of pulses. It is found that the laser processing results in the formation of various micro- and nanostructures with characteristics that can be controlled via the laser parameters. The obtained structures express optical properties defined by the plasmon excitation. The fabricated structures show efficiency as active substrates in surface enhanced Raman spectroscopy.

**Acknowledgements:** The research that led to these results was carried out with the help of infrastructure purchased under the National Roadmap for Scientific Infrastructure (ELI-ERIC-BG), financially coordinated by the Ministry of Education and Science of the Republic of Bulgaria under project D01-351. The authors also acknowledge the support from the bilateral agreement between the Bulgarian and the Polish Academies of Sciences under contract No. IC/PL/17/2024-2025.

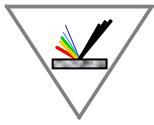

## P.A8

### NANO AND MICRO-STRUCTURING OF METAL-DOPED CaP SURFACE VIA LASER PROCESSING FOR BIOMIMETIC AND ANTIBACTERIAL ORTHOPEDIC IMPLANTS

M. Oliveira, L. Angelova, A. Daskalova

*Institute of Electronics, Bulgarian Academy of Sciences, 72 Tsarigradsko Chaussee Blvd,  
1784 Sofia, Bulgaria*

*e-mail: [moliveirall97@gmail.com](mailto:moliveirall97@gmail.com)*

Bacterial infections contribute significantly to implant failure in orthopedic applications, necessitating materials with excellent biocompatibility and robust antibacterial properties. Beta-tricalcium phosphate ( $\beta$ -TCP), widely used for bone regeneration due to its bio-mimetic characteristics, remains susceptible to bacterial colonization [1]. The femtosecond (fs) laser technology offers precise surface modifications without significant thermal effects or alteration of intrinsic properties [2]. Incorporating antibacterial ions, such as copper (Cu), strontium (Sr), silver (Ag), and magnesium (Mg), into  $\beta$ -TCP can potentially enhance its antimicrobial efficacy [3-5].

In this study, we applied fs laser processing to  $\beta$ -TCP pellets doped with Cu, Sr, Ag, and Mg ions utilizing various laser energies, scanning velocities, and patterns to optimize the surface characteristics. Scanning electron microscopy (SEM) revealed laser-induced periodic surface structures (LIPSS)-like features, known for their antibacterial properties [6]. The results from optical profilometry indicated increased surface roughness under all tested conditions, potentially disrupting bacterial adhesion and inhibiting biofilm formation. Water contact angle (WCA) measurements suggested increased hydrophilicity, which could facilitate the efficient release of antibacterial ions [6].

To mimic clinical ion release, extracts from each sample were tested at different concentrations against human bone marrow (hBM) cells and *Staphylococcus aureus* (*S. aureus*). The results showed increased viability of hBM cells and decreased viability of bacteria, indicating that the modified surfaces can potentially enhance biocompatibility and possess significant antibacterial properties.

This study suggests that fs laser treatment combined with doping  $\beta$ -TCP with antibacterial ions is a promising strategy of enhancing the bio-mimetic, biocompatibility, and antibacterial properties of  $\beta$ -TCP, thus addressing the critical issue of bacterial infections in orthopedic implants.

#### References:

- [1] M. Bohner, B. L. Santoni, N. Döbelin, “ $\beta$ -tricalcium phosphate for bone substitution: Synthesis and properties” *Acta Biomater.*, 113, 23-41, (2020)
- [2] K. Sugioka, Y. Cheng, “Femtosecond laser three-dimensional micro- and nanofabrication”, *Appl. Phys. Rev.*, 1, 041303, (2014)
- [3] K. Demishtein, R. Reifen, M. Shemesh, “Antimicrobial Properties of Magnesium Open Opportunities to Develop Healthier Food”, *Nutrients*, 11(10), 2363, (2019)
- [4] N. Baheiraei, H. Eyni, B. Bakhshi, R. Najafloo, N. Rabiee, “Effects of strontium ions with potential antibacterial activity on in vivo bone regeneration”, *Sci. Rep.*, 11, 8745, (2021)



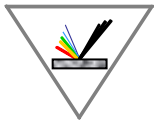

[5] S. Mittapally, R. Taranum, S. Parveen, “Metal ions as antibacterial agents”, *J. Drug Deliv. Ther.*, 8(6-s), 411–9, (2018)

[6] I. Georgakopoulos-Soares, E. L. Papazoglou, P. Karmiris-Obratański, N. E. Karkalos, A. P. Markopoulos, “Surface antibacterial properties enhanced through engineered textures and surface roughness: A review”, *Colloids and Surfaces B: Biointerfaces*, 231, 113584, (2023)

**Acknowledgements:** This work was supported by the European Union’s H2020 research and innovation program under the Marie Skłodowska-Curie Grant Agreement AIMed No. 861138.

## P.A9

### ASSESSMENT OF METHODS FOR DETERMINING THE COLOR PROPERTIES OF LASER-ENGRAVED DENIM FABRIC

B. Stoyanov, I. Banev, D. Kovacheva

*Technical University of Gabrovo, 4 H. Dimitar str., 5300 Gabrovo, Bulgaria*

*e-mail: [b.stoyanov@tugab.bg](mailto:b.stoyanov@tugab.bg)*

In this study, the decolorization was investigated of denim exposed to 1064 nm laser light. The bleaching procedure proceeds by irradiating the fabric by directing the beam by means of a scanning head. The effect of bleaching is obtained by processing parallel lines, hatches, on the fabric with different beam power and distance between the lines. Treatment of indigo dyed 100% cotton denim fabric was carried out by ytterbium pulsed fiber laser with 20 W output power at a wavelength of 1064 nm and a repetition rate of 20 kHz. Color fading was investigated using a spectrophotometer and evaluation of the Weber contrast. The  $L$ ,  $a$ ,  $b$  coefficients are compared to digitally measured Weber values. Based on this, the research reveals a set of laser processing parameters to produce faded denim effects with different color impact appropriate for the modern design industry.

#### References:

[1] A. Ozguney, G. Ozcelik, K. Ozkaya, “A study of specifying the effect of laser fading process on the colour and mechanical properties of the denim fabrics”, *Textile and Apparel.*, 19(2), 133-8, (2009)

[2] A. Sakib, T. Islam, M. Islam, et al., “Analysis the physical properties of laser fading on denim fabric”, *J. Textile Eng Fashion Technol.*, 5(6), 288-290, (2019)

[3] B. Stoyanov., Kr. Drumev, D. Genov, “Fashion design using laser engraving technology”, *Journal of the Technical University of Gabrovo*, 52, 53-57, (2016)

[4] B. Stoyanov, Kr. Drumev, D. Genov, “Microscope analysis of laser treated cotton fabrics”, *Journal of the Technical University of Gabrovo*, 52, 58-60, (2016)

[5] C. Kan, W. Yuen, C. Cheng, “Technical study of the effect of CO<sub>2</sub> laser surface engraving on the colour properties of denim fabric”, *Color Technol.*, 126, 365–371, (2010)

[6] L. Lazov, E. Teirumnieks, N. Petrov, Ē. Teirumnieka, “Methodology for Automatic Determination of Contrast of Laser Marking for Different Materials”, *Environment. Technology. Resources, Proceedings of the International Scientific and Practical Conference*, 3, 134, (2019)

[7] L. Lazov, H. Deneva, P. Narica, “Factors influencing the color laser marking” In: *Proceedings of the 10th international scientific and practical conference: Environment. Technology. Resources, Rezekne, Latvia, June 2015*, 102–107, (2015)

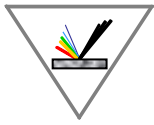

- [8] M. Juciene, V. Urbelis, Ž. Juchnevičienė, et al., “The effect of laser technological parameters on the color and structure of denim fabric”, *Text. Res. J.*, 84(6), 662–670, (2013)
- [9] N. Dolchinkov, “Practical research of marking and cutting of textiles with increased resistance, using CO<sub>2</sub> laser”, *J. Phys.: Conf. Ser.*, 1681, 012014, (2020)
- [10] P. Venkatraman, C. Liauw, “Use of a carbon dioxide laser for environmentally beneficial generation of distressed/faded effects on indigo dyed denim fabric: Evaluation of colour change, fibre morphology, degradation and textile properties”, *Optics & Laser Technology*, 111, 701-13, (2018)
- [11] Y. Shterev, N. Dolchinkov, S. Lilianova, et al., “Examining the possibility of marking and engraving of textile using CO<sub>2</sub> laser”, *Mach. Technol. Mater.*, 12(12), 491–493, (2018)

**Acknowledgements:** This work was supported by the Bulgarian National Scientific Fund under Grant 2411M.

## P.A10

### PLASMON-ENHANCED PHOTOLUMINESCENCE OF LASER-PRODUCED NOBLE METAL/SEMICONDUCTOR COMPOSITE NANOSTRUCTURES

Mihaela Koleva<sup>1,2</sup>, Anna Dikovska<sup>1</sup>, Nikolay Nedyalkov<sup>1</sup>, Tsanislava Genova<sup>1</sup>,  
Georgi Avdeev<sup>3</sup>

<sup>1</sup>*Institute of Electronics, Bulgarian Academy of Sciences, 72 Tsarigradsko Chaussee Blvd.,  
1784 Sofia, Bulgaria*

<sup>2</sup>*Neofit Rilski South-Western University, 66 Ivan Mihailov Str., 2700 Blagoevgrad, Bulgaria*

<sup>3</sup>*Rostislaw Kaischew Institute of Physical Chemistry, Bulgarian Academy of Sciences,  
Acad. G. Bonchev Str., bl. 11, 1113 Sofia, Bulgaria*

*e-mail: [mihaela\\_ek@yahoo.com](mailto:mihaela_ek@yahoo.com)*

The efforts to tailor the optical properties of metal oxide semiconductors by noble metal nanoparticles (NPs) have acquired great attention in recent years. Improving the ZnO performance in combination with noble metals (Ag, Au, Pt, Pd) is important for applications in optoelectronic devices. In this work, results are presented on pulsed laser deposition (PLD) of composite noble metal/zinc oxide thin films by picosecond laser pulses at atmospheric pressure (open air) and room temperature. A picosecond Nd:YAG laser operating at a wavelength of 1064 nm and a fluence of 0.5 J cm<sup>-2</sup> is used to deposit composite layers on SiO<sub>2</sub> (001) substrates. The subsequent laser treatment of the surfaces by nanosecond laser pulses in air under different processing conditions enables alterations of their morphology and, respectively, their optical properties. The effect is studied of the microstructure and composition on the optical properties of the nanostructures. The laser modification causes a change in the resonance absorption band, which contributes to an adjustment of the band-edge and deep level photoluminescent (PL) emission. The photoluminescence is investigated of noble metal/semiconductor composite nanostructures synthesized by ps-laser ablation before and after the ns-laser annealing. Enhancement of the broad-band near-ultraviolet PL peak of ZnO in the presence of noble metal nanoparticles (NPs) is registered, together with changes in the broad multi-component visible emission feature.

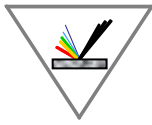

## P.A11

### SOME INITIAL RESULTS ON MODIFICATION OF aC:H FILMS BY PULSED LASER IRRADIATION

D. Karaivanova<sup>1</sup>, A. Dikovska<sup>1</sup>, K. Kirilov<sup>2</sup>, E. Valcheva<sup>2</sup> and T. Milenov<sup>1</sup>

<sup>1</sup>*Institute of Electronics, Bulgarian Academy of Sciences, 72 Tsarigradsko Chaussee, 1784 Sofia, Bulgaria*

<sup>2</sup>*Faculty of Physics, University of Sofia, 5 James Bourchier Blvd., 1164 Sofia, Bulgaria*

*e-mail: [karaivanova1888@abv.bg](mailto:karaivanova1888@abv.bg)*

It has been shown both theoretically [1] and experimentally [2,3] that a distinguishable modification of the aC:H films is possible using UV. For example, the sp<sup>3</sup>- hybridized carbon as well as the oxygen-containing radicals content decreases notably by UVC irradiation [2]. In our further experiments, treatment was used with pulsed laser irradiation ( $\lambda = 266$  nm of a nanosecond Nd: YAG laser system) [3].

In the present work, we show the results of processing aC thin films deposited on Si (001) substrates with a deposited 330-nm thin film of SiO<sub>2</sub> with UVC radiation from a mercury lamp as well as with 266 nm laser radiation. The films obtained were mainly characterized by Raman spectroscopy and the results of the UV treatment were compared with those of aC films deposited on Si (001) substrates.

#### References:

[1] S. Kolev et al., “Surface chemistry of reduced graphene oxide: H-atom transfer reactions”, *Appl. Surf. Sci.*, 567, 150815, (2021)

[2] T. I. Milenov et al., “Modification of graphene-like, hydrogenated amorphous, hydrogenated tetrahedral amorphous carbon and amorphous carbon thin films by UV-C light”, *Surfaces & Interfaces*, 24, 101073, (2021)

[3] T. I. Milenov et al., “Some Initial Results on Modification of aC: H Films by Pulsed Laser Irradiation”, *J. Phys.: Conf. Ser.*, 2487, 012009, (2023)

**Acknowledgements:** The authors gratefully acknowledge financial support by the National Science Fund of Bulgaria under grant KP-06-H58/2 – 16.11.2021.

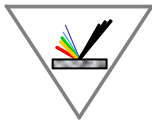

## P.A12

### LASER-ASSISTED SYNTHESIS OF INORGANIC NANOCOMPOSITES FOR INCORPORATION IN POLYMETHYL METHACRYLATE FREESTANDING FILMS

N. Stankova<sup>1</sup>, N. Nedyalkov<sup>1</sup>, A. Dikovska<sup>1</sup>, A. Nikolov<sup>1</sup>, D. Karashanova<sup>2</sup>

<sup>1</sup>*Institute of Electronics, Bulgarian Academy of Sciences, 72 Tsarigradsko Chaussee Blvd, 1784 Sofia, Bulgaria*

<sup>2</sup>*Institute of Optical Materials and Technologies, Bulgarian Academy of Sciences, Acad. Georgy Bonchev Str, 1113 Sofia, Bulgaria*

*e-mail: [nestankova@yahoo.com](mailto:nestankova@yahoo.com)*

Composite nanostructures of inorganic metals were synthesized by pulsed laser ablation in liquids (PLAL) and were subsequently incorporated in polymethyl methacrylate (PMMA) to form freestanding films. Pulsed radiation of a picosecond Nd:YAG laser at the fundamental wavelength (1064 nm) was used to prepare TiO<sub>x</sub>/Ag/Au/Pt/Pd and Fe/Ag/Au/Pt/Pd nanocomposites in organic (ethanol, acetone) or inorganic (water) liquids in various combinations. Subsequently, the colloids were mixed with a PMMA solution and left to dry in room environment to obtain freestanding thin films. The optical transmission and photoluminescence properties and the morphological and structural characteristics of the colloids and the films were investigated by optical and Raman spectroscopy and transmission electron microscopy. These PMMA-based nanocomposites could be extensively used in various optoelectronic devices and coatings because their optical properties could be tailored easily for specific applications, such as removal of photocatalytic contaminants and antibacterial films, by varying the associated nanofiller components and by controlling their size and shape.

## P.A13

### SURFACE MODIFICATION OF TITANIUM TARGET BY LASER ABLATION IN ORGANIC SOLUTIONS

Ro. Nikov<sup>1</sup>, Ru. Nikov<sup>1</sup>, N. Nedyalkov<sup>1</sup>, St. Valkov<sup>1</sup>, L. Aleksandrov<sup>2</sup>, M. Sawczak<sup>3</sup>,  
K. Grochowska<sup>3</sup>, R. Jendrzewski<sup>3</sup>

<sup>1</sup>*Institute of Electronics, Bulgarian Academy of Sciences, 72 Tsarigradsko Chaussee, 1784 Sofia, Bulgaria*

<sup>2</sup>*Institute of General and Inorganic Chemistry, Bulgarian Academy of Sciences, Acad. G. Bonchev Str., Bl. 11, 1113 Sofia, Bulgaria*

<sup>3</sup>*The Szewalski Institute of Fluid-Flow Machinery, Polish Academy of Sciences, 14 Fiszerza St, 80-231 Gdansk, Poland*

*e-mail: [rosen\\_nikov@abv.bg](mailto:rosen_nikov@abv.bg)*

The work presents results on nanosecond laser ablation of a titanium (Ti) plate immersed in a liquid medium. The fundamental wavelength (1064 nm) of a nanosecond Nd:YAG laser system was used in the ablation process. The laser irradiation was focused on the target surface, as scanning was accomplished by an X-Y translation stage. The laser processing of the Ti target was performed in two different organic liquids – ethanol and toluene. The morphology and phase composition of the structured surfaces were explored by scanning electron microscopy

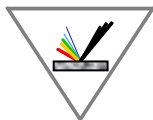

and X-ray diffraction measurements, respectively. The formation was found of a carbide phase with properties that could be tuned by varying the laser parameters. The proposed technique can be used in surface modification of materials for mechanical properties improvement.

**Acknowledgements:** This work was supported by the bilateral project IC-PL/17/24-25 between the Bulgarian Academy of Sciences and the Polish Academy of Sciences.

## P.A14

### LANGMUIR–BLODGETT FILMS OF FLUORESCENTLY-LABELED PHOSPHOLIPIDS FOR NANO-BIO-SENSORS CHARACTERIZED BY LASER- INDUCED FLUORESCENCE

George R. Ivanov<sup>1</sup>, Georgi B. Hadjichristov<sup>2</sup>, Yordan G. Marinov<sup>2</sup>

<sup>1</sup>*Nanoscience and Nanotechnology University Laboratory,  
University of Architecture, Civil Engineering and Geodesy, 1 H. Smirnenski Blvd,  
1064 Sofia, Bulgaria*

<sup>2</sup>*Georgi Nadjakov Institute of Solid State Physics, Bulgarian Academy of Sciences,  
72 Tsarigradsko Chaussee Blvd, 1784 Sofia, Bulgaria*

*e-mail: [ygmartinov@gmail.com](mailto:ygmartinov@gmail.com)*

We studied the structural properties of organic single monolayers of the fluorescently head-labeled phospholipid Nitrobenzoxadiazole Dipalmitoyl Phosphatidyl Ethanolamine (NBD-DPPE). Nano-thin (~10 nm) Langmuir-Blodgett films (LBFs) of NBD-DPPE were deposited on solid substrates. The preparation of such phospholipid single monolayers of the DPPE, which is bound to molecules of the organic fluorescent compound NBD, aims at their sensing applications, e.g., for detection of harmful metal ions and volatile organic compounds [1–3]. The structure of the produced single monolayers was characterized by means of laser-induced fluorescence (LIF), fluorescence microscopy and atomic force microscopy (AFM). The LIF data for the deposited NBD-DPPE LBFs were interrelated to the structural data obtained by fluorescence microscopy and AFM. Corresponding conclusions about the structural properties of the considered NBD-DPPE single monolayers were made, useful for optimizing their density and the technology of their deposition by the LB method. The results of this study reveal that the deposited nano-thin NBD-DPPE LBFs exhibit 3D aggregates and, therefore, a surface with a high surface-to-volume ratio, promising to achieve high sensitivity and fast response time in sensing applications.

#### References:

[1] G.R. Ivanov, I.D. Avramov, V.J. Strijkova, Y.G. Marinov, T.E. Vlahov, E. Bogdanova, G.B. Hadjichristov, “Mass sensitivity of Langmuir-Blodgett monolayer film coated surface acoustic wave resonators to volatile organic solvents”, *J. Phys. Conf. Ser.*, 1762, 012002, (2021)

[2] T.E. Vlahov, G.R. Ivanov, Y.G. Marinov, G.B. Hadjichristov, “Phospholipid Langmuir-Blodgett films and impedance spectroscopy for detection of acetone and methanol vapors”, *C. R. Acad. Bulg. Sci.*, 74(6), 828-834, (2021)

[3] G.B. Hadjichristov, Y.G. Marinov, T.E. Vlahov, N. Scaramuzza, “Phospholipid Langmuir-Blodgett nano-thin monolayers: electrical response to Cadmium ions and harmful volatile organic compounds”, *Adv. Biomembr. Lipid Self-Assem.*, 34, 129-172, (2021)

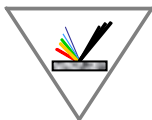

**Acknowledgements:** Work supported by the Ministry of Education and Science of Bulgaria through the National Science Fund of Bulgaria (research project "Explanation and extension of the discovered by us new effects in nano-thin organized organic films for the development of nanocomposite chemical sensors for fast, real-time, in-field gas sensing and monitoring of emerging organic contaminants in drinking water (Acronym–NanoSense)", No KP-06-N68/3/2023).

## P.A15

### LASER-BEAM OPTO-DIELECTRIC SPECTROSCOPY FOR THE STUDY OF NANOCOMPOSITES FROM 5CB NEMATIC LIQUID CRYSTALS AND POLYMER-COATED GOLD NANOPARTICLES

Georgi B. Hadjichristov<sup>1</sup>, Yordan G. Marinov<sup>1</sup>, George R. Ivanov<sup>2</sup>, Alexander G. Petrov<sup>1</sup>

<sup>1</sup>*Georgi Nadjakov Institute of Solid State Physics, Bulgarian Academy of Sciences,  
72 Tsarigradsko Chaussee Blvd, 1784 Sofia, Bulgaria*

<sup>2</sup>*Nanoscience and Nanotechnology University Laboratory, University of Architecture, Civil Engineering and Geodesy, 1 H. Smirnenski Blvd, 1064 Sofia, Bulgaria*

*e-mail: [ygmarinov@gmail.com](mailto:ygmarinov@gmail.com)*

Opto-dielectric spectroscopy was applied to studying the dielectric and flexo-electric response of nematic nanocomposite system composed of the well known nematic liquid crystal pentyl-cyano-biphenyl (5CB) and polymer-coated gold nanoparticles (AuNPs). The AuNPs/5CB samples were in the form of planar films with a thickness of 25  $\mu\text{m}$ , where AuNPs with a mean diameter of 20 nm were homogeneously dispersed in 5CB. The concentration of AuNPs in 5CB was 0.5 wt%. The technique of opto-dielectric spectroscopy was implemented using a power-stabilized single-mode He-Ne laser beam passed through the thin AuNPs/5CB films (Fig. 1). In the same direction (across the films), an alternating-current (AC) electric field was applied to the films. The AC field frequency was scanned in the range from 1 Hz to 3 kHz. The recorded opto-dielectric spectra of electro-optical modulation behavior of the AuNPs/5CB nanocomposite nematic system were thoroughly analyzed to determine the effect of the included AuNPs. The electro-optical and flexo-electric properties of the studied AuNPs/5CB nanocomposites are interesting for applications in electro-optics, photonics and mechatronics.

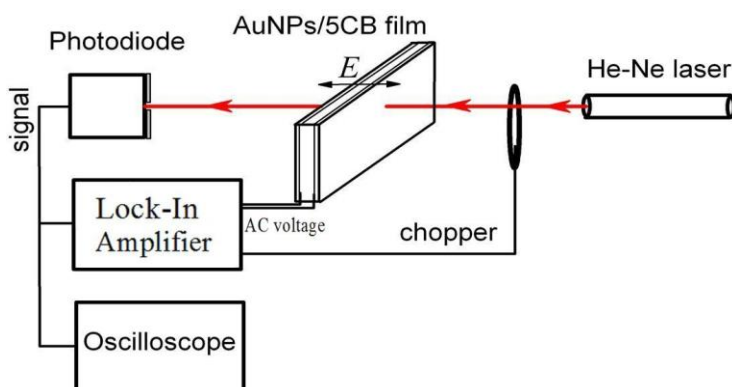
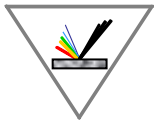

Fig. 1. Schematic diagram of the experiment.

**Acknowledgements:** This work was supported by the Ministry of Education and Science of Bulgaria, through the National Science Fund of Bulgaria (research projects "Liquid crystal



**XXIII International Conference and School on Quantum Electronics:  
“Laser Physics and Applications”**

nanocomposites for applications in photonics, sensors and biomedicine", No KP-06-N58/6/2021.

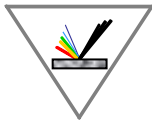

## P.B1

### NEW FEATURES OF THE DARK STATE RESONANCES ON THE POTASSIUM D2 LINE IN HANLE CONFIGURATION FOR MAGNETOMETRY APPLICATIONS

S. Tsvetkov and S. Gateva

*Institute of Electronics, Bulgarian Academy of Sciences, 72 Tsarigradsko Chaussee Blvd,  
1784 Sofia, Bulgaria*

*email: [stocvet@ie.bas.bg](mailto:stocvet@ie.bas.bg)*

Magneto-optical spectroscopy is widely used in many scientific fields. A major feature of this type of coherent spectroscopy is the possibility to register narrow high-contrast magneto-optical resonances (MOR) [1], whose width is determined by the ground-state hyperfine (hf) level lifetime. Potassium (K) vapor is one of the most applied alkali atom vapors for optically pumped atomic magnetometers, as the frequency difference of the two ground levels in the hyperfine structure (hs) is smaller than the Doppler width of the optical transitions. The overlapping of the Doppler profiles emerging from the two ground-state levels can provide re-population of the ground hf levels resonantly excited by the light and enhance the efficiency of the magneto-optical transitions. Lastly, the nonlinearity of the Zeeman splitting dependence on the magnetic field is more significant than that for other alkali atoms and the isotopic shifts of the two stable isotopes (39K, 41K) are smaller than the Doppler width [2].

In a few of our previous works [3, 4, 5], we have demonstrated the possibility to measure the laboratory magnetic field gradients by a relatively simple experimental setup consisting of a DFB laser tuned to the D2 line of potassium whose light propagates through a magnetically unshielded optical cell containing potassium vapor and Ne buffer gas. A pair of Helmholtz coils induce a linearly scanned magnetic field through the cell in two cases: orthogonal to beam direction [3] or longitudinal [4, 5] leading to a magnetic sub-level crossing Hanle resonances displaced proportionally by laboratory magnetic field gradients. In [3], optical sidebands are produced in the emission line on both sides of the central Hanle resonance by modulating the current of the laser at a constant phase relationship, matching the energy distance between the Zeeman sublevels. In [4, 5], MORs are registered not only in emission, but also in fluorescence leading to the possibility to observe different MF gradients in one measurement under specific conditions, such as density and laser polarization.

In this work, we combined the two experiments detecting fluorescence simultaneously with the absorption signal in the orthogonal MF set-up to investigate the influence of temperature and laser intensity on the optical sidebands. We observed new remarkable distortion and sign reversal of the sidebands at higher densities, similar to the effect observed in [4] at the central Hanle resonance.

The results are interesting from the point of view of in-depth understanding of the process of sign reversal of the MORs and also might serve as a basis for the development of a simple unshielded self-calibrated magnetometer.

#### References:

[1] S. Gozzini, A. Fioretti, A. Lucchesini, L. Marmugi, C. Marinelli, S. Tsvetkov, S. Gateva, S. Cartaleva, “Tunable and polarization-controlled high-contrast bright and dark coherent resonances in potassium”, *Opt. Lett.*, 42, 15, (2017)

[2] D. Bloch, M. Ducloy, N. Senkov, V. Velichansky, V. Yudin, “Doppler-Free Spectroscopy of the D<sub>2</sub> Line of Potassium”, *Laser Phys.*, 6(4), 670, (1996)



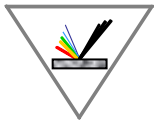

[3] A. Krasteva, S. Gateva, A. Sargsyan, D. Sarkisyan, S. Cartaleva, “Dark resonances in potassium vapor for absolute measurement of magnetic fields”, Bulg. Chem. Commun., 48, 178, (2016)

[4] S. Tsvetkov, C. Andreeva, S. Gateva, “Coherent magneto-optical resonances on the potassium D2 line in Hanle configuration for magnetometry applications”, J. of Phys.: Conf. Ser., 2487, 012014, (2023)

[5] S. Tsvetkov, S. Gateva, “Optical control of coherent magneto-optical resonances in potassium”, J. Phys.: Conf. Ser., 2710, 012026, (2024)

## P.B2

### INFLUENCE OF THE LASER EXCITATION LINEWIDTH ON THE PARAMETERS OF EIA RESONANCES IN $^{87}\text{Rb}$

E. Taskova<sup>1</sup>, N. Petrov<sup>1</sup>, P. Todorov<sup>1</sup> and C. Andreeva<sup>1,2</sup>

<sup>1</sup>*Academician Emil Djakov Institute of Electronics, Bulgarian Academy of Sciences,  
72 Tsarigradsko Chaussee Blvd., 1784 Sofia, Bulgaria*

<sup>2</sup>*Faculty of Physics, St. Kliment Ohridski University of Sofia, 5 James Bourchier Blvd.  
1164 Sofia, Bulgaria*

*e-mail: [taskova@ie.bas.bg](mailto:taskova@ie.bas.bg)*

The influence is examined of the spectral linewidth of single-mode lasers on the parameters of the electromagnetically induced absorption (EIA) resonances in rubidium vapor. This investigation is interesting for many applications where improving the signal-to-noise ratio of the EIA resonances allows more sensitive measurement of weak magnetic fields.

We use two counter-propagating pump and probe beams in a paraffin-coated optical cell containing  $^{87}\text{Rb}$  to prepare high-contrast magneto-optical EIA resonances [1]. The Rb vapor is irradiated either by a Fabry-Perot diode laser with a linewidth of 50 MHz or by a distributed feedback (DFB) single-frequency laser with a linewidth of 5 MHz tuned on the  $D_1$  line. Due to the different spectral linewidth of the excitation laser, various classes, i.e., numbers of atoms are involved in creating the EIA resonance, which changes its parameters.

This study aims to improve the amplitude-to-width ratio by optimizing the magneto-optical resonance width for the needs of magnetometry [2].

#### References:

[1] E. Taskova, E. Alipieva, C. Andreeva and D. Brazhnikov, “Electromagnetically induced absorption resonances in Hanle-configuration prepared in a paraffin coated  $^{87}\text{Rb}$  cell”, J. Phys.: Conf. Ser., 1492(1), 012011, (2020)

[2] E. Alipieva, S. Gateva and E. Taskova, “Potential of the single-frequency CPT resonances for magnetic field measurement”, IEEE Trans. Instrum. Meas., 54(2), 738-741, (2005)

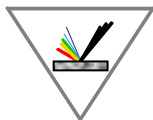

## P.B3

### EXCITATION-EMISSION MATRICES FLUORESCENCE SPECTROSCOPY FOR ANALYSIS OF BULGARIAN TRADITIONAL WINE VARIETIES

Lidia Zaharieva<sup>1</sup>, Tsanislava Genova<sup>1</sup>, Yana Medarska-Georgieva<sup>2</sup>, Kamelia Gechovska<sup>2</sup>, Ivan Angelov<sup>1</sup>, Aleksandra Zhelyazkova<sup>1</sup>, Victoria Mircheva<sup>1</sup>, Vera Deneva<sup>2</sup>, Christina Andreeva<sup>1,3</sup>, Asparuh Markovski<sup>4</sup>, Daniela Nedeltcheva-Antonova<sup>2</sup>, Liudmil Antonov<sup>1</sup>

<sup>1</sup>*Institute of Electronics, Bulgarian Academy of Sciences, 72 Tsarigradsko Chaussee Blvd., 1784 Sofia, Bulgaria*

<sup>2</sup>*Institute of Organic Chemistry with Centre of Phytochemistry, Bulgarian Academy of Sciences, Acad. G. Bonchev bl.9, 1113 Sofia, Bulgaria*

<sup>3</sup>*Faculty of Physics, St. Kliment Ohridski University of Sofia, 5 James Bourchier Blvd., 1164 Sofia, Bulgaria*

<sup>4</sup>*Faculty of Automatics, Technical University of Sofia, Bulgaria*

*e-mail: [liudmil.antonov@gmail.com](mailto:liudmil.antonov@gmail.com)*

Bulgaria is rich in indigenous grape varieties such as Mavrud, Shiroka Melnishka Loza, Gamza, Misket Cherven, and Dimyat, which have been cultivated for millennia. Despite this long tradition, these Bulgarian wines have not been extensively studied. There is a need for a quick and cost-effective method to monitor these wines, beneficial for both the industry and society. To address this, 127 commercial wine samples were collected—91 red, 24 white, and 12 rosé—from the 2015 to 2023 harvests across various regions of Bulgaria. These samples include both single grape varieties and blends of two or three varieties.

In this study, we focused on using excitation-emission matrices fluorescence spectroscopy as a method for analyzing and classifying the different wine varieties. The measurements were conducted using a FluoroLog3 spectrofluorimeter (HORIBA Jobin Yvon, France) and covered excitation wavelengths ranging from 260 to 400 nm in 5-nm steps, and a detection interval from 280 to 800 nm. This technique exploits the presence of natural fluorophores in wines, such as amino acids, flavonoids and phenolic acids, providing unique fluorescence fingerprint for every wine [1,2].

The results will be used for a statistical analysis, which will help create a database for Bulgarian wine varieties, supporting the wine industry. Additionally, this database will serve as a valuable resource for researchers aiming to enhance the quality and consistency of Bulgarian wines, providing a foundation for future innovations in viticulture and enology.

#### References:

[1] D. Airado-Rodriguez, T. Galeano-Diaz, I. Duran -Meras, J. P. Wold, “Usefulness of Fluorescence Excitation-Emission Matrices in Combination with PARAFAC, as Fingerprints of Red Wines”, *J. Agric. Food Chem.*, 57, 1711–1720, (2009)

[2] RC. Suciu, L. Zarbo, F. Guyon, et al. “Application of fluorescence spectroscopy using classical right-angle technique in white wines classification”, *Sci. Rep.* 9, 18250, (2019)

**Acknowledgements:** Bulgarian National Science Fund contract is acknowledged for the financial support for this investigation (project KP-06-KOST/17).

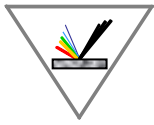

## P.C1

### TYPOLOGY AND CLIMATOLOGY OF THE AEROSOL FIELD OVER SOFIA, BULGARIA

Eleonora Toncheva, Tsvetina Evgenieva, Ljuan Gurdev, Tanja Dreischuh

*Institute of Electronics, Bulgarian Academy of Sciences, 72, Tsarigradsko Chaussee, Blvd.,  
1784 Sofia, Bulgaria*

*e-mail: [etoncheva@ie.bas.bg](mailto:etoncheva@ie.bas.bg)*

The purpose of the present work is to reveal and report the typological and climatological evolution of the aerosol situations over Sofia, Bulgaria during the period 1 March 2022 – 29 February 2024 and to compare the peculiarities found with those concerning the preceding period from 5 May 2020 to 28 February 2022. The investigations performed are based on AERONET-provided data extracted from Cimel CE318-TS9 sun/sky/lunar photometer measurements on the optical and microphysical characteristics of the aerosol field over the Sofia Aerosol Remote Sensing Station, involved also in the pan-European research infrastructure ACTRIS and in the European networks EARLINET and E-Profile.

The further analysis of the data shows that the frequency distributions of the individually measured realizations of  $AOD_{440}$  and  $AE_{440/870}$  during both periods have similar characteristics. In general, with some nuances, the  $AOD_{440}$  distributions are bimodal, and the  $AE_{440/870}$  distributions are three-modal. The peak positions of the modes of  $AOD_{440}$  and  $AE_{440/870}$  are very close, as are their mean values.

The scatter plot that will be shown for the period under consideration here of the daily-mean aerosol situations represented as daily-mean  $AE_{440/870} - AOD_{440}$  aerosol events outlines similar aerosol typology and climatology to those during the preceding period. In the scatter plot, the events are naturally divided by type into six groups (zones), roughly delineated by one vertical line,  $AOD_{440} = 0.32$ , and two horizontal lines,  $AE_{440/870} = 1$  and  $AE_{440/870} = 1.3$ . The boundaries of the zones and the types of aerosols they cover – biomass-burning (BB), mixed (MA), Saharan dust (SD), and urban (UA) aerosols, are nearly the same as in the preceding time period. The scatter plot-based aerosol classification is confirmed by using AERONET data, desert-dust spread forecasting models and air mass transport and dispersion models, and satellite images of fire outbreaks around the world. The relative occurrences of BB, MA, SD and UA from 1 March 2022 to 29 February 2024 are assessed to have been near the corresponding values concerning the previous period, with only some small differences. That is, the relative number of cases of UA decreased slightly, while that of MA, BB smoke and SD increased.

Thus, one may conclude that, in general, the annual aerosol circulation over Sofia is relatively steady and reproducible from a statistical, typological and climatological point of view. Nevertheless, each year has its own specificity conditioned by irregular global and regional phenomena.

**Acknowledgements:** This work is supported by the Ministry of Education and Science of Bulgaria (support for ACTRIS BG, part of the National Roadmap for Research Infrastructure) and by the European Commission under the Horizon 2020 – Research and Innovation Framework Program, Grant Agreement No. 871115 (ACTRIS IMP).

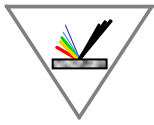

## P.C2

### DIAL SOUNDER OF ATMOSPHERIC GREENHOUSE GASES IMPLEMENTING HIGH-POWER BROADBAND LASER DIODES AND SPECTROSCOPIC CORRELATION TECHNIQUE

Stoyan Penchev, Vasilka Pencheva, Tanja Dreischuh

*Emil Djakov Institute of Electronics, 72 Tsarigradsko Chaussee, 1784 Sofia, Bulgaria*

*e-mail [spenchev@ie.bas.bg](mailto:spenchev@ie.bas.bg)*

The greenhouse effect of humidity and methane in the low atmosphere a few kilometers above Earth's surface is important from the viewpoint of ecology, meteorology and weather forecasting. Currently, the controlling measurements are insufficient for the highly variable atmospheric conditions. Using a lidar (laser radar) is advantageous in obtaining continuous real-time data of high temporal and spatial resolution. Particularly, a differential absorption lidar (DIAL) is advantageous in retrieving range-resolved data on atmospheric scattering and simultaneous measurement of resonance molecular absorption by the atmospheric gas content.

We contributed to pioneer studies advancing an effective DIAL technique by replacement of narrowband lasers with their broadband counterparts [1]. The method is based on the spectroscopic correlation technique developed for high-power pulsed laser diodes of selected wavelengths that match confined segments of the integral absorption spectrum. Such broadband lidar detects the monitored integral absorption spectrum of the gas instead of an isolated resonance line that depends on pressure broadening. Implementation of the near-infrared (NIR) broadband high-power laser diodes for that task is favorable, matching the sensitive avalanche photodetectors that do not need cooling to low temperatures. Also, the thermal stabilization of the laser wavelength is essentially simplified using such laser diodes owing to the integral character of the detected absorption spectrum. A comparison is reported of an active and a passive integrated emitter-detector schemes of the original DIAL method.

A) Two complementary optical channels of paired high-power pulsed laser diodes that utilize the properties of the strong absorption band of water vapor 0.86-0.91  $\mu\text{m}$  [2]. The detected DIAL signal calibrated by the derived absorption function of the laser broad-line radiation is independent of the variable atmospheric pressure and temperature.

B) An effective solution for remote sensing of methane absorption spectrum centered at 1.667  $\mu\text{m}$  by multiplexation of the broad laser line eliminates the strong interference of water vapor [3]. The resonance absorption spectrum of Q<sub>2</sub>v<sub>3</sub> second overtone rotational-stretching vibration is selected using calculated parameters of the absorption function and HITRAN (high-resolution transmission and molecular absorption) software.

#### References:

[1] B. Thomas, G. David et al., “Remote sensing of atmospheric gases with optical correlation spectroscopy and lidar: first experimental results on water vapor profile measurements”, *Appl. Phys. B.*, 113, 265–275, (2013)

[2] V. Pencheva, S. Penchev, T. Dreischuh, “DIAL hygrometer based on powerful laser diodes: calibration function and modulation of laser radiation”, *J. Phys. Conf. Ser.*, 2487, (2023)

[3] S. Penchev, V. Pencheva, T. Dreischuh, “Method and broadband lidar for sounding of atmospheric methane”, Patent 67612, (2024)

**Acknowledgements:** This research has been supported by the Bulgarian Ministry of Education and Science, part of the Bulgarian National Roadmap for Research Infrastructure ACTRIS BG.

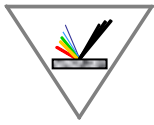

## P.C3

### ANALYSIS OF A WINTERTIME SAHARAN DUST EVENT OVER SOFIA, BULGARIA, USING MULTIPLE SENSORS

Liliya Vulkova<sup>1</sup>, Zahari Peshev<sup>1</sup>, Tsvetina Evgenieva<sup>1</sup>, Anatoli Chaikovsky<sup>2</sup>, Vladislav Pescherenkov<sup>2</sup>, Stefan Dosev<sup>1</sup>, Atanaska Deleva<sup>1</sup> and Tanja Dreischuh<sup>1</sup>

<sup>1</sup>*Institute of Electronics, Bulgarian Academy of Sciences, 72 Tsarigradsko Chaussee Blvd,  
1784 Sofia, Bulgaria*

<sup>2</sup>*I. Stepanov Institute of Physics, National Academy of Sciences of Belarus, 68-2  
Nezavisimosti av., 220072 Minsk, Belarus*

*e-mail: [angelova@ie.bas.bg](mailto:angelova@ie.bas.bg)*

The airborne desert mineral dust can significantly impact the thermal regime and radiation balance of the atmosphere, as well as the air quality, ecosystems, and human health. Therefore, it is a subject of constant monitoring and extensive scientific research all over the world.

In this work, we present a multi-sensor analysis and characterization of a wintertime Saharan dust load event in the atmosphere above Sofia, Bulgaria, which was a part of an intense large-scale dust episode conditioned by a persistent synoptic-scale blocking weather pattern over North Africa, the Mediterranean, and Europe [1,2].

Integrating data from remote (lidar, radiometric, and satellite) and *in situ* (PM<sub>10</sub>) measurements, as well as data from modeling, forecasting, and reanalysis resources, a wide range are obtained of columnar and height/time-resolved optical, microphysical, physical, topological, and dynamical characteristics of the detected aerosols dominated by desert dust. The LIRIC-2 inversion code is utilized combining lidar and sun-photometer data, for retrieving vertical profiles of the aerosol/dust total and mode volume concentration.

The results acquired demonstrate that the appropriate combination and application of different techniques, tools, and data have a significant synergistic effect and the potential to support the validation and enhancement of theoretical models aimed at a more thorough aerosol/dust parameterization and characterization.

#### References:

[1] E. Cuevas-Agulló, D. Barriopedro, R. D. García, S. Alonso-Pérez, J. J. González-Alemán, E. Werner, D. Suárez, J. J. Bustos, G. García-Castrillo, O. García, Á. Barreto, and S. Basart, “Sharp increase in Saharan dust intrusions over the western Euro-Mediterranean in February–March 2020–2022 and associated atmospheric circulation”, *Atmos. Chem. Phys.*, 24, 4083-4104, (2024)

[2] Z. Peshev, A. Chaikovsky, Ts. Evgenieva, V. Pescherenkov, L. Vulkova, A. Deleva, T. Dreischuh, “Combined Characterization of Airborne Saharan Dust above Sofia, Bulgaria, during Blocking-Pattern Conditioned Dust Episode in February 2021”, *Remote Sens.*, 15, 3833, (2023)

**Acknowledgements:** This research was supported by the Ministry of Education and Science of Bulgaria (support for ACTRIS BG, part of the Bulgarian National Roadmap for Research Infrastructure) and by the European Commission under the Horizon 2020 – Research and Innovation Framework Program, Grant Agreement No. 871115 (ACTRIS IMP).

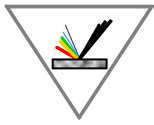

## P.C4

### EXTREME HEAT WAVES OVER EUROPE IN JULY 2023: LIDAR AND SUN-PHOTOMETER OBSERVATIONS OF SAHARAN DUST LOADS ABOVE SOFIA, BULGARIA

Stefan Dosev, Zahari Peshev, Tsvetina Evgenieva, Liliya Vulkova, Ljuan Gurdev,  
Ivan Grigorov, Luybomir Popov and Tanja Dreischuh

*Institute of Electronics, Bulgarian Academy of Sciences, 72 Tsarigradsko Chaussee,  
1784 Sofia, Bulgaria*

*e-mail: [stefand@ie.bas.bg](mailto:stefand@ie.bas.bg)*

Unusual weather occurrences, such as extreme air temperatures or release of large quantities of desert dust into the atmosphere spreading across vast regions, are closely connected to ongoing global climate change. In July 2023, a sequence of heat waves impacted Europe due to a strong anticyclone zone located over the Central Mediterranean and North Africa. In Bulgaria, from 9-26 July, the near-surface temperatures ranged from 35-40°C, with some local temperatures reaching 40-43°C, significantly exceeding the usual climate norms across the entire country. The Mediterranean and South Europe experienced a large transport of Saharan dust during the extreme heat waves, which also affected the Balkan Peninsula. The dust plume reached Bulgaria on 12 July and persisted until 26 July, causing dust load values of nearly 1000 mg/m<sup>2</sup>.

The desert dust event was continuously monitored by the Sofia (IE-BAS) ACTRIS/EARLINET/AERONET station during the heat-wave period. The station's Raymetrics 8-channel Depolarization Raman lidar LR332-D300 ( $3\beta-2\alpha-2\delta$ ) was used for performing lidar measurements, whereas the solar irradiance measurements were effectuated by the collocated 9-channel Cimel CE318-TS9 sun/sky/lunar photometer. Below are reported findings related to the height of the initial dust intrusion. Data from web resources available online was utilized to model and predict aerosol/dust transport. These resources were also used to (re)analyze related climatic and climatological conditions and factors.

Both daytime and nighttime lidar measurement data were used for retrieving the aerosol/dust backscatter at 1064 nm, 532 nm, and 355 nm. The measurements with the nighttime lidar configuration Raman channels at 387 nm and 607 nm allowed retrieval of extinction and lidar ratio profiles at 355 nm and 532 nm.

A significant set of AERONET columnar aerosol parameters was determined for analyzing and characterizing the dust event under consideration. Such parameters are total and size-mode aerosol optical depth, Ångström exponent, lidar ratio, linear depolarization ratio, single-scattering albedo, and volume size distribution. Dynamic mapping was also performed of the aerosol vertical stratification and/or height profiling of aerosol backscattering coefficient, extinction, lidar ratio, Ångström exponent, and volume linear depolarization ratio from lidar measurements. Vertical profiles of meteorological data from radiosonde measurements and model analyses are also presented.

The results obtained indicate that the regional and local atmospheric conditions, along with the composition and structure of the troposphere, were significantly impacted by the extreme weather conditions and desert air masses during the dust event. It is also shown that these could potentially disrupt local ecosystems and pose serious health risks to humans.

**Acknowledgements:** This research was supported by the Ministry of Education and Science of Bulgaria (support for ACTRIS BG, part of the Bulgarian National Roadmap for Research

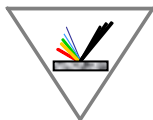

Infrastructure) and by the European Commission under the Horizon 2020 — Research and Innovation Framework Program, Grant Agreement No. 871115 (ACTRIS IMP).

## P.D1

### A COMPARATIVE STUDY ON FLUORESCENCE AND RAMAN SPECTROSCOPY FOR DISCRIMINATION OF ESSENTIAL OILS

A. Zhelyazkova<sup>1</sup> and Ts. Genova<sup>1</sup>

<sup>1</sup>*Institute of Electronics, Bulgarian Academy of Sciences, 72 Tsarigradsko Chaussee Blvd.,  
1784 Sofia, Bulgaria*

*e-mail: [alexandra\\_jivkova@abv.bg](mailto:alexandra_jivkova@abv.bg)*

Essential oils (EOs) have been used since antiquity to treat and alleviate various diseases and conditions thanks to their antiviral, anti-inflammatory, antifungal, antibacterial, organoleptic, antimicrobial, and regenerative properties [1]. These oils are complex mixtures of volatile organic compounds with distinctive aromas. EOs are lipophilic, meaning they are not soluble in water but can dissolve in alcohols. Essential oils are extracted from plants or specific parts of plants (such as flowers, leaves, roots, or bark) through steam distillation, cold pressing, or other extraction methods. Because of their biological properties, EOs are commercially significant in the pharmaceutical, food, perfumery, and cosmetic industries. Additionally, essential oils exhibit fluorescent properties and characteristic Raman spectra, making spectral measurements useful for their detection, discrimination, quality control, imaging, and studying their synergy.

We utilize fluorescence and Raman spectroscopy as rapid and cost-effective methods for characterizing, discriminating, and ensuring the quality of essential oils. By scanning the excitation and emission wavelengths in specific intervals, the results can be graphically displayed as a contour plot against fluorescence intensity for each excitation-emission wavelength pair. This 3D contour plot, known as the Excitation Emission Matrix (EEM), is a valuable tool for distinguishing similar compounds through multi-component analysis. On the other hand, Raman spectra serve as a unique fingerprint for each chemical substance, based on the molecule's polarizability concerning its vibrational motion. Combining these techniques provides specific spectral characteristics suitable for the classification and quality control of essential oils.

#### References:

- [1] P. Bisman, T. Kerista, T. Takdir, “Fluorescence Spectra Measurement of Essential Oils”, *J. Phys.: Conf. Ser.*, 1230, 012035, (2019)
- [2] M. Hanif, H. Nawaz, S. Naz, R. Mukhtar, N. Rashid, I. Bhatti, M. Saleem, “Raman spectroscopy for the characterization of different fractions of hemp essential oil extracted at 130°C using steam distillation method”, *Spectrochimica Acta Part A: Molecular and Biomolecular Spectroscopy*, 182, (2017)
- [3] P. Vargas, C. Sandoval, P. Zárate, M. Sinche, G. Jácome, V. Rueda-Ayala, V. Ciobotă, “Raman spectroscopy in the detection of adulterated essential oils: The case of nonvolatile adulterants”, *Journal of Raman Spectroscopy*, 52, 1055-1063, (2021)

**Acknowledgements:** This work is supported by the National Science Fund of the Bulgarian Ministry of Education and Science under grant #KP-06-N 38/13/2019.

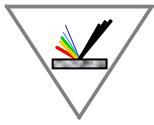

## P.D2

### CUTTING EDGE TECHNIQUE FOR DETERMINATION OF SPATIAL RESOLUTION LIMITS OF NONLINEAR LASER SCANNING MICROSCOPY

M. Bukumira<sup>1</sup>, J. Jelić<sup>1</sup>, A. Denčevski<sup>1</sup>, M. D. Rabasović<sup>1</sup>, N. Vujičić<sup>2</sup>, A. Senkić<sup>2</sup>, A. Supina<sup>2</sup>, L. Žužić<sup>3</sup>, B. Radatović<sup>4</sup>, T. Pajić<sup>5</sup>, A. Krmpot<sup>1</sup>

<sup>1</sup>*Institute of Physics Belgrade, University of Belgrade, Laboratory for Biophysics,  
Belgrade, Serbia*

<sup>2</sup>*Institute of Physics, Center of Excellence for Advanced Materials and Sensing Devices,  
Zagreb, Croatia*

<sup>3</sup>*Department of Physics, University of Zagreb, Zagreb, Croatia*

<sup>4</sup>*Materials Science Factory, Instituto de Ciencia de Materiales de Madrid (ICMM-CSIC),  
Madrid, Spain*

<sup>5</sup>*Department for General Physiology and Biophysics, Faculty of Biology, University of  
Belgrade, Serbia*

*e-mail: [marta@ipb.ac.rs](mailto:marta@ipb.ac.rs)*

The resolution of a microscope, defined as the shortest distance between two points that can be distinguished as separate entities, is fundamentally limited by the wave nature of light and the phenomenon of diffraction. Even under theoretically ideal conditions and optical components, microscopes possess finite resolution.

In this study, we apply the knife-edge technique to the sharp edges of WS<sub>2</sub> and MoS<sub>2</sub> monolayer flakes for assessing lateral and axial resolution in all three modalities of nonlinear laser scanning microscopy: two-photon-excited fluorescence, second- and third-harmonic generation imaging. This technique offers a high signal-to-noise ratio, no photobleaching effect, and shows strong agreement with standard resolution measurement techniques.

We directly assessed lateral resolution in the two-photon-excited fluorescence imaging modality and axial resolution in the second- and third-harmonic generation imaging modalities directly, through the full-width at half-maximum parameter of the corresponding Gaussian distribution. A comprehensive analysis was conducted on factors affecting resolution, such as numerical aperture, excitation wavelength, and the refractive index of the embedding medium for achieving resolutions closest to the theoretical limit.

The proposed use of WS<sub>2</sub> and MoS<sub>2</sub> monolayer flakes are promising tools for characterizing nonlinear imaging systems.

**Acknowledgements:** This research was supported by the Science Fund of the Republic of Serbia, Grant No. 4545, project “Advanced Biophysical Methods for Soil Targeted Fungi-Based Biocontrol Agents” - BioPhysFUN; and the Institute of Physics Belgrade, through the grant by the Ministry of Science, Technological Development and Innovations of the Republic of Serbia. A.S., B.R. and N.V. acknowledge the support of Croatian Science Foundation, Grant No. UIP-2017-05-3869, Centre of Excellence for Advanced Materials and Sensing Devices, ERDF Grant No. KK.01.1.1.01.0001 and Centre for Advanced Laser Techniques, ERDF Grant KK.01.1.1.05.



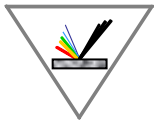

## P.D3

### IN VIVO INVESTIGATION OF THE EFFECTS OF NAIL ART ON THE NAIL PLATE THROUGH OPTICAL METHODS

V. Mircheva<sup>1</sup>, Ts. Genova<sup>1</sup>, L. Zaharieva<sup>1</sup>, Al. Zhelyazkova<sup>1</sup>, L. Avramov<sup>1</sup>

<sup>1</sup>*Institute of Electronics, Bulgarian Academy of Sciences, 72 Tsarigradsko Chaussee Blvd.,  
1784 Sofia, Bulgaria*

*email: [victoriamircheva@gmail.com](mailto:victoriamircheva@gmail.com)*

The history of nail art dates back to as early as 3000 B.C., when the ancient Egyptians were known for decorating their nails with henna. By the early 20th century, women all over the world had embraced nail art as an accessible way of expressing their individual styles. Nowadays, nail beautification is an invariable part of most women's lives. Having healthy, beautiful, and trendy manicure also boosts women's self-confidence. However, the modern nail beautification industry relies heavily on a photo-polymerization process that hardens colored synthetic resins (gel-polish) when exposed to ultraviolet or visible light. There are two aspects to this procedure, which pose a threat to the health: first, the exposure to UV light and, second, the process of resins removal. It involves soaking in acetone and/or aggressive buffing or scraping, which can injure the nail plate. Also, wearing gel polish for long periods may cause severe brittleness and dryness of the nails. Therefore, it is of interest to investigate the effects and possible damages to the nail caused by gel polish.

In this work, we will present an evaluation of the effects of nail art and nail beautification on in vivo nail plate through optical coherence tomography and diffuse reflectance spectroscopy. Nail plate abnormalities and irregularities, such as the post-progressive nail-art effect on the nail plate, affect the backscattered light signal. A comparison of optically valuable parameters determines the significance of the effects on the nail. The possible complications arising from these effects will be discussed.

**Acknowledgements:** The investigations were supported by the Bulgarian National Science Fund under grants #KP06/H38/13, as well under Ministry of Education and Science NRRI 2020-2027 funding agreement #D01-352/13.12.2023 “National Center of Biomedical Photonics”.

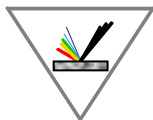

## P.D4

### PHOTODYNAMIC INHIBITION OF PATHOLOGY- ACCOMPANYING ENZYMES: EFFECT OF IRRADIATION SPECTRA

Diana Braikova<sup>1</sup>, Ivan Angelov<sup>1,2</sup> and Vanya Mantareva<sup>1</sup>

<sup>1</sup>*Institute of Organic Chemistry with Centre of Phytochemistry, Bulgarian Academy of Sciences, Acad. G. Bonchev, str., Bl. 9, 1113 Sofia, Bulgaria*

<sup>2</sup>*Institute of Electronics, Bulgarian Academy of Sciences, 72 Tsarigradsko Chaussee Blvd., 1784 Sofia, Bulgaria*

*e-mail: [mantareva@yahoo.com](mailto:mantareva@yahoo.com)*

The photosensitive compounds of natural and synthetic origin have been found as capable of being involved in a wide collection of photo-physicochemical processes, including biomedical and ecological approaches. This is based on their ability to absorb light in the visible or near IR spectral ranges with the proper formation of reactive oxidative species by specific light excitation. Herbs and bioactive products are examples of natural compounds providing high efficiency [1]. The present study describes a readily accessible, reproducible and easy-to-use method based on enzymic inhibition and useful in evaluating the photosensitizing capacity of natural compounds as photosensitizers for photodynamic therapy.

In the present study, photosensitizers were used of different structural origin and absorption and fluorescence spectra. Curcumin, a plant-derived polyphenolic compound naturally present in turmeric (*Curcuma longa*), is a well-known photosensitizer with an absorption maximum at 425 nm and fluorescence at 530 nm. Phthalocyanines belong to the porphyrinoids absorbing at ~680 nm with a red-shifted fluorescence emission > 690 nm [2]. The enzymic inhibition was registered using casein as a substrate and irradiation by a blue or red light-emitting diode (LED 455 nm and LED 660 nm); an acidity media (pH 2-6) imitating the environment of malignances; and monitoring the proteolytic activity in turbid media. The light sources were applied in a manner allowing a comparison between the effect of the two irradiation spectra. The study suggested the advantages of achieving photosensitization by porphyrinoids rather than by natural curcumins. Further studies on malignant and pathogenic cells are in progress to determine the potential of the method based on enzymes' inhibition to be useful for prompt evaluation of the photodynamic capability of novel photosensitizers for PDT.

#### References:

[1] V. Mantareva, D. Braikova, I. Lazarova, T. Genova, “Plants-occurring Anthraquinones as Photosensitive Compounds for Photodynamic Method: A Critical Overview”, *Frontiers in Bioscience-Landmark*, 29, 5, 168-181, (2024)

[2] E. Borisova, Ts. Genova, A. Yakimansky, V. Mantareva, I. Angelov, A. Gisbrecht, Al. Khorovodov, I. Agranovich, M. Klimova, and O. Semyachkina-Glushkovskaya “Conjugation of Zn (II) phthalocyanine with polymeric brushes for improved photodiagnostics and photodynamic therapy of gastric tumours”, *Proc. SPIE 11457, Saratov Fall Meeting 2019: Optical and Nano-Technologies for Biology and Medicine*, 114570R, (2020)

**Acknowledgements:** To the Bulgarian National Science Fund for the support with the project KII-06-H38/13/2019.

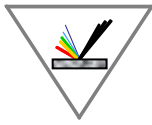

## P.D5

### INFLUENCE OF THE SCANNING FREQUENCY ON THE SURFACE TOPOGRAPHY OF ELECTRON-BEAM MODIFIED Ti6Al4V ALLOY

Ivana Ilievska<sup>1</sup>, Maria Ormanova<sup>1</sup>, Borislav Stoyanov<sup>2</sup>, Georgi Kotlarski<sup>1</sup>,  
Andreana Andreeva<sup>3</sup>, Stefan Valkov<sup>1,2</sup>

<sup>1</sup>*E. Djakov Institute of Electronics, Bulgarian Academy of Sciences, 72 Tsarigradsko  
Chaussee Blvd, 1784 Sofia, Bulgaria*

<sup>2</sup>*Technical University of Gabrovo, 4 H. Dimitar Str., 5300 Gabrovo, Bulgaria*

<sup>3</sup>*Faculty of Physics, St. Kliment Ohridski University of Sofia, 5 James Bourchier Blvd,  
1164 Sofia, Bulgaria*

*e-mail: [ivannyilievska@gmail.com](mailto:ivannyilievska@gmail.com)*

In this work, the influence was investigated of the scanning frequency on the surface topography of electron-beam surface modified Ti6Al4V alloy. The experiments were realized on an evoBeam cube 6-kW equipment for electron-beam surface modification processes. During the experiments, the accelerating voltage was 60 kV, the current of the electron beam was 5 mA, and the speed of the sample motion was 10 mm/s. The geometry of the electron beam scanning was linear, with the scanning frequency being varied from 200 Hz to 1000 Hz. The phase compositions of the surface-modified samples and of an unmodified one were studied by X-ray diffraction (XRD). The microstructure of the specimens was studied by scanning electron microscopy (SEM). The surface topography was studied by means of atomic force microscopy (AFM). The results obtained were discussed concerning the potential application of these materials in the field of modern biomedicine and implant manufacturing.

**Acknowledgements:** This research was funded by the Bulgarian National Science Fund, grant number KP-06-N67-5 (2022).

## P.D6

### NIR-TRIGGERED SYNERGISTIC PHOTO-CHEMOTHERAPY USING NANOARCHAEOSOMES AND GRAPHENE OXIDE NANOMATERIALS

Renugaa Suresh<sup>1</sup>, Poornima Budime Santhosh<sup>2,3</sup>, Lyubomir Stoychev<sup>2</sup>, Kamelia Hristova-Panusheva<sup>4</sup>, Natalia Krasteva<sup>4</sup>, Julia Genova<sup>2</sup>, Swathi Sudhakar<sup>1</sup>

<sup>1</sup>*Department of Applied Mechanics and Biomedical Engineering, Indian Institute of  
Technology Madras, Chennai, India*

<sup>2</sup>*Institute of Solid State Physics, Bulgarian Academy of Sciences, 72 Tsarigradsko Chaussee,  
1784 Sofia, Bulgaria*

<sup>3</sup>*Central Laboratory of Solar Energy and New Energy Sources, 72 Tsarigradsko Chaussee,  
1784 Sofia, Bulgaria*

<sup>4</sup>*Institute of Biophysics and Biomedical Engineering, Bulgarian Academy of Sciences, Acad.  
G. Bonchev str. Bl.21, 1113 Sofia, Bulgaria*

*e-mail: [poorni@issp.bas.bg](mailto:poorni@issp.bas.bg)*

Breast cancer is the most common type of cancer in women, with its prevalence increasing steeply worldwide. Traditional cancer therapeutic methods have several drawbacks and side effects, leading to an urgent need of exploration of smart materials and efficient drug-delivery

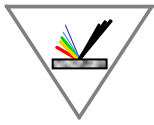

systems [1, 2]. In this regard, we have synthesized NIR laser-responsive nanoarchaeosomes (NA), which are novel and biocompatible nano-sized liposomes synthesized using archaeal lipids. The NA were encapsulated with PEGylated Graphene oxide (PEG-GO) nanoparticles and cisplatin (CIS), an anticancer drug, to form an NA-PEG-GO-CIS complex. This complex was characterized by using a series of analytical techniques, namely, transmission electron microscopy (TEM), dynamic light scattering (DLS), and UV-Vis spectroscopy. Under irradiation by an 808-nm wavelength laser ( $0.1 \text{ W cm}^{-2}$ , 5 min), the PEG-GO nanoparticles effectively induced localized photothermia and controlled drug release from the NA. *In vitro* studies in MCF-7 breast cancer cells demonstrated that this complex exhibits enhanced cellular uptake and significantly reduced cell viability. Further, the angiogenic activity of the NA-PEG-GO-CIS complex was tested using a chick embryonic model by quantifying the blood vessels length, diameter, and sprouting count. Our findings suggest that our system not only enhances the therapeutic index of the drug but provides a less invasive and promising strategy to realize chemo-photothermal synergistic therapy for breast cancer.

#### References:

- [1] L. Karthikeyan, R. Vivek, “Synergistic anti-cancer effects of NIR-light responsive nanotherapeutics for chemo-photothermal therapy and photothermal immunotherapy: A combined therapeutic approach”, *Adv. Cancer Biol. Metastasis*, 4, 100044, (2022)
- [2] N. Krasteva, D. Staneva, B. Vasileva, G. Miloshev, M. Georgieva, “Bioactivity of PEGylated graphene oxide nanoparticles combined with near-infrared laser irradiation studied in colorectal carcinoma cells”, *Nanomaterials (Basel)*, 11, 3061, (2021)

**Acknowledgements:** The authors acknowledge financial support from the Bulgarian National Science Fund under project Grant No: KP-06-N78/8 (14.12.2023) and fund from Indian Government Grant No: SP23242582AMSERB009000, & IP23242000AMIITM009000.

## P.D7

### MACHINE LEARNING WITH INSUFFICIENT DATA FOR CLASSIFICATION OF FOOD OIL MIXTURES BY MEANS OF LIF SPECTRA

A. Markovski<sup>1</sup>, L. Zaharieva<sup>2</sup>, Ts. Genova<sup>2</sup> and C. Andreeva<sup>2,3</sup>

<sup>1</sup>*Faculty of Automatics, Technical University of Sofia, Bulgaria*

<sup>2</sup>*Institute of Electronics, Bulgarian Academy of Sciences, 72 Tsarigradsko Chaussee Blvd., 1784 Sofia, Bulgaria*

<sup>3</sup>*Faculty of Physics, St. Kliment Ohridski University of Sofia, 5 James Bourchier Blvd., 1164 Sofia, Bulgaria*

*e-mail: [c.andreeva@ie.bas.bg](mailto:c.andreeva@ie.bas.bg)*

In recent years, the algorithms of artificial intelligence (AI) have been developed extensively and have attracted the increasing attention of scientists, since they open doors to efficient solutions of many problems that would otherwise require much time, effort, expenses and, often, inspiration. A main challenge to their wider application in biophotonics is the lack of ample amount of diverse and representative data for training. Therefore, we present here the application of Neural Network (NN) algorithms trained with insufficient data for solving a task related to the classification of mixtures of food oils (sunflower and extra-virgin olive oil) with different concentrations for verification of food quality. The task will be approached both as a classification and as a fitting task. The cases of training with raw data and with diagnostic parameters with biochemical meaning and also when extending the insufficient datasets with

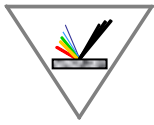

**XXIII International Conference and School on Quantum Electronics:  
“Laser Physics and Applications”**

and without adding noise will be reported. The outputs of different approaches for treating the insufficient data problem will be compared.

**Acknowledgements:** The experimental part of the work was financially supported by the Fund for Scientific Research at the St. Kliment Ohridski University of Sofia, grant No 80-10-41/09.04.2024. A.M. acknowledges the financial support of project “Improving the research capacity and quality to achieve international recognition and resilience of TU-Sofia (IDEAS)” for the machine learning part of the work.

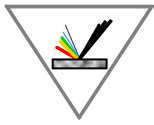

**POSTER SESSION II**

**P.E1**

**GOLD VAPOR LASER OSCILLATING IN VISIBLE AND ULTRAVIOLET  
SPECTRAL RANGES ON ATOMIC GOLD SELF-TERMINATING TRANSITIONS**

I. K. Kostadinov, K. A. Temelkov, S. I. Slaveeva

*Institute of Solid State Physics, Bulgarian Academy of Sciences, 72 Tsarigradsko Chaussee,  
1784 Sofia, Bulgaria*

*e-mail: [temelkov@issp.bas.bg](mailto:temelkov@issp.bas.bg)*

Metal vapor lasers oscillating on atomic self-terminating transitions of various chemical elements, such as copper, gold, strontium, etc., are very attractive due to their high output characteristics at a relatively high efficiency. Among these prospective laser sources, copper vapor lasers and their various versions remain the most developed and studied because of the highest average output power in the visible spectral range and their applicability in a large variety of applications.

Gold vapor lasers (GVLs) operating at the atomic gold lines at 312.2 nm and 627.8 nm are less investigated and developed because of the severe difficulties related to the extremely high operating temperature and the significantly higher requirements for the high-voltage pulsed power supply. The highest average output power of 20 W at the 627.8-nm line has been delivered by a laser tube with an active volume of 2376 cm<sup>3</sup> (55 mm inner diameter and 100 cm length) at a pulse repetition rate of 5.5 kHz and an average electrical power of 15.7 kW [1]. A laser tube with an active volume of 232 cm<sup>3</sup> (22 mm inner diameter and 61 cm length) has produced at the 627.8-nm line an average laser power of 11.6 W at a pulse repetition rate of 27.5 kHz and an average electrical power of 3.9 kW [2]. These results correspond to a wall-plug efficiency of 0.30% and a specific average output power (SOAP) of 0.050 W cm<sup>-3</sup> [2], which are the highest efficiency and SOAP reported for a GVL. For comparison, the efficiency and SOAP presented in [1] are 0.13% and 0.008 W cm<sup>-3</sup>, respectively. Weak laser oscillation at the 312.2-nm line has been also observed in [2], but the average laser power has been insufficient to be accurately measured. A laser tube with an active volume of 18.4 cm<sup>3</sup> (6 mm inner diameter and 65 cm length) has delivered an average output power of 110 mW at the 312.2-nm line [3].

A GVL with a 4.5-mm bore and an active length of 51 cm (active volume of 8.1 cm<sup>3</sup>), which produces a maximum average output power of 1.43 W at the 627.8-nm line, is developed and investigated, i.e. a record-high SOAP of 0.176 W cm<sup>-3</sup> is achieved for lasers oscillating at the 627.8-nm line. The obtained SOAP is 3.5, i.e., 22 times higher than the values reported in [2] and [1]. An average laser power of 90 mW is achieved at the 312.2-nm line, which is comparable to the result obtained in [3]. This value corresponds to a SOAP of 11.1 mW cm<sup>-3</sup>, which is 1.8-fold higher than the one reported in [3].

**References:**

- [1] S. Gabay, I. Hen, M. Lando, “A high power gold vapor laser”, Proc. SPIE, 1225, 260–267, (1990)
- [2] G. D. Marshall, D. W. Coutts, “High Power (> 10 W) Gold Vapor Laser with Second and Third Harmonics for Telecommunication and Engineering Applications”, IEEE Journal of Quantum Electronics, 49, 8, 711-718, (2013)

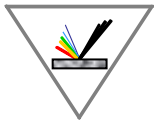

[3] S. V. Markova, G. G. Petrash, V. M. Cherezov, “Ultraviolet-emitting gold vapor laser”, *Quantum Electronics*, 5, 7, 904-906, (1978)

**Acknowledgements:** The work is supported by the Bulgarian Science Fund under Grant No. KP-06-H77/8 of 04.12.2023.

## P.E2

### COPPER VAPOR LASER OSCILLATING IN THE ULTRAVIOLET SPECTRAL RANGE THROUGH SECOND HARMONIC GENERATION

I. K. Kostadinov, K. A. Temelkov, S. I. Slaveeva, L. I. Stoychev

*Institute of Solid State Physics, Bulgarian Academy of Sciences, 72 Tsarigradsko Chaussee, 1784 Sofia, Bulgaria*

*e-mail: [temelkov@issp.bas.bg](mailto:temelkov@issp.bas.bg)*

Precise microprocessing by laser ablation is one of the basic laser applications in various fields of science and in advanced technologies in the industry and medicine. The main goal is to remove efficiently and controllably a defined amount of material with the least amount of collateral damage (affected zones) with the process of laser ablation. Since the diameter of the processed area after focusing depends linearly on the laser radiation wavelength, lasers oscillating in the ultraviolet (UV) spectral range are the most suitable for precise micromachining. Besides achieving the necessarily high resolution, these lasers have a sufficiently high photon energy to induce various phenomena in different media, such as bulk and surface modification, image recording, fluorescence, etc. Nowadays, several UV laser sources are generally used, as follows: excimer lasers, frequency-quadrupled and frequency-tripled Nd:YAG and Nd:YLF lasers, frequency-doubled argon ion lasers and frequency-doubled dye lasers.

UV laser sources based on nonlinear frequency conversion of copper vapor laser (CVL) radiation at a high pulse repetition rate (5-20 kHz) is a quite competitive alternative. CVLs operate at the atomic copper 510.6- and 578.2-nm lines. UV radiation at 255.3 nm, 289.1 nm and 271.2 nm has been generated by frequency doubling the 510.6-nm and 578.2-nm output and by sum-frequency generation, respectively [1-3]. Frequency doubling the 510.6-nm radiation of a CVL system by using cesium lithium borate and  $\beta$ -barium borate (BBO) nonlinear crystals has been compared in [3]. Both high-beam-quality radiation and high laser intensity are required for efficient frequency doubling.

Two laser tubes with active volumes of 2.1 cm<sup>3</sup> (3 mm inner diameter and 30 cm length) and 7.5 cm<sup>3</sup> (4 mm inner diameter and 60 cm length), respectively, are developed. The output parameters and beam quality of each laser tube are studied with a negative-branch confocal unstable cavity. The output characteristics of a master oscillator–power amplifier system are also investigated. Potassium dideuterium phosphate (KDP) and BBO nonlinear crystals are used for second harmonic generation and sum-frequency mixing.

#### References:

[1] R. Pini, R. Salimbeni, M. Vannini, “Efficient second harmonic generation in  $\beta$ -barium borate by a diffraction-limited copper vapor laser”, *Applied Optics*, 31, 15, 2747-2751, (1992)

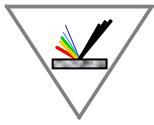

[2] D. W. Coutts, D. J. W. Brown, “Production of High Average Power UV by Second-Harmonic and Sum-Frequency Generation from Copper-Vapor Lasers”, *IEEE Journal of Selected Topics in Quantum Electronics*, 1, 3, 768-778, (1995)

[3] D. J. W. Brown, M. J. Withford, “High-average-power (15-W) 255-nm source based on second-harmonic generation of a copper laser master oscillator power amplifier system in cesium lithium borate”, *Optics Letters*, 26, 23, 1885-1887, (2001)

**Acknowledgements:** The work is supported by the Bulgarian Science Fund under Grant No. KP-06-H77/8 of 04.12.2023.

## P.E3

### ROGUE WAVE CLUSTERS OF THE EXTENDED NONLINEAR SCHRÖDINGER EQUATIONS

Stanko N. Nikolić<sup>1,2</sup> and Milivoj R. Belić<sup>2</sup>

<sup>1</sup>*Institute of Physics Belgrade, University of Belgrade, Pregrevica 118,  
11080 Belgrade, Serbia*

<sup>2</sup>*Division of Arts and Sciences, Texas A&M University at Qatar, P.O. Box 23874,  
Doha, Qatar*

*e-mail: [stankon@ipb.ac.rs](mailto:stankon@ipb.ac.rs), [milivoj.belic@qatar.tamu.edu](mailto:milivoj.belic@qatar.tamu.edu)*

**Keywords:** Quintic nonlinear Schrödinger equation, Darboux transformation, Rogue wave clusters.

We analyze three types of rogue wave (RW) clusters for the quintic nonlinear Schrödinger equation (QNLSE) on a flat background. The exact QNLSE solutions are generated using the Darboux transformation (DT) scheme and they are composed of the higher-order Akhmediev breathers (ABs) and Kuznetsov-Ma solitons (KMSs) [1]. We analyze the dependence of their shapes and intensity profiles on the eigenvalues and evolution shifts in the DT scheme and on three real quintic parameters. The first type of RW clusters, characterized by the periodic array of peaks along the evolution or transverse axis, is obtained when the condition of commensurate frequencies of DT components is applied. The elliptical RW clusters are computed from the previous solution class when the first  $m$  evolution shifts in the DT scheme of order  $n$  are equal and nonzero. For both AB and KMS solutions, a periodic structure is obtained with the central RW and  $m$  ellipses, containing the first-order maxima that encircle the central peak. We show that RW clusters built on KMSs are significantly more vulnerable to the application of high values of QNLSE parameters, in contrast to the AB case. We next present non-periodic long-tail KMS clusters. They are characterized by the rogue wave at the origin and  $n$  tails above and below the central point containing the first-order KMSs. We also show that the breather-to-soliton conversion can transform the shape of RW clusters by careful adjustment of the real parts of DT eigenvalues, while remaining parameters are left unchanged.

#### References:

[1] S. N. Nikolić, N. B. Aleksić, M. R. Belić, “Akhmediev and Kuznetsov-Ma rogue wave clusters of the higher-order nonlinear Schrödinger equation”, *Opt. Quant. Electron.*, 56, 1182, (2024)



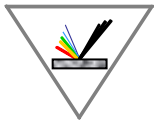

## P.E4

### INVESTIGATION OF NONLINEAR PROPERTIES OF FIBROIN (SF) USING THE Z-SCAN METHOD

G. Yankov<sup>1</sup>, S. Karatodorov<sup>1</sup>, V. Atanassova<sup>1</sup>, K. S. Shumanov<sup>2</sup>, A. Daskalova<sup>2</sup>, E. Filipov<sup>2</sup>,  
L. Angelova<sup>2</sup>, E. Iordanova<sup>1</sup>

<sup>1</sup>*Institute of Solid State Physics, Bulgarian Academy of Sciences, 72 Tsarigradsko Chaussee,  
1784 Sofia, Bulgaria*

<sup>2</sup>*Institute of Electronics, Bulgarian Academy of Sciences, 72 Tsarigradsko Chaussee,  
1784 Sofia, Bulgaria*

*e-mail: [eiordanova@issp.bas.bg](mailto:eiordanova@issp.bas.bg)*

Silk fibroin is the primary protein in silkworm silk. It exhibits excellent mechanical properties and high biocompatibility, making it suitable for various high-tech applications, including nonlinear optics.

Current research employs the z-scan method as an effective tool for measuring materials' nonlinear coefficients to investigate the nonlinear optical properties of fibroin (SF). The method consists of focusing a laser beam through a transparent sample to measure the difference in optical transmittance as a function of the sample's position relative to the focal point. This allows for determining the material's nonlinear refractive index and nonlinear absorption coefficient.

The obtained data reveal that silk fibroin exhibits a high nonlinear refractive index and absorption coefficient, indicating its strong potential for nonlinear optical applications.

**Acknowledgements:** The present work is funded by the Bulgarian National Science Fund by Grant No KP-06-H58/7 “Plasma dynamics and formation induced by femtosecond infrared laser pulses in transparent media”.

## P.E5

### LINEAR OPTICS OF BROAD-BAND LASER PULSES. DIFFRACTION AND DISPERSION

P. Miteva<sup>1</sup>, D. Dakova<sup>3</sup>, D. Georgieva<sup>1</sup>, E. Iordanova<sup>2</sup>, G. Yankov<sup>2</sup>, K. L. Kovachev and  
L. M. Kovachev<sup>1</sup>

<sup>1</sup>*Institute of Electronics, Bulgarian Academy of Sciences, 72 Tsarigradsko Chaussee,  
1784 Sofia, Bulgaria*

<sup>2</sup>*Institute of Solid State Physics, Bulgarian Academy of Sciences, 72 Tsarigradsko Chaussee,  
1784 Sofia, Bulgaria*

<sup>3</sup>*Physics and Technology Faculty, Paisii Hilendarski University of Plovdiv, 24 Tsar Asen Str.,  
4000 Plovdiv, Bulgaria*

*email: [pkancheva.physics@gmail.com](mailto:pkancheva.physics@gmail.com)*

The linear and nonlinear propagation dynamics of broad-band laser pulses is quite different from narrow-band ones. In this work, we present different types diffraction and dispersion regimes of narrow-band and broad-band laser pulses and compare them to find the difference. In the fs region, when a laser pulse propagates in air the dispersion length is of the order of the

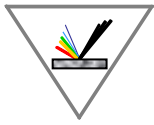

diffraction one, while a reduced diffraction is observed experimentally. The theoretical investigation of this regime shows a very good agreement with the experiments. While for narrow band pulses we can use spatio-temporal Fresnel type approximation to solve analytically the problems, for broad-band ones this is not possible. To follow the evolution dynamics of broad-band laser pulses, we solve numerically the inverse Fourier transform from the corresponding spectral representation of the non-paraxial amplitude equation. New type of chirped  $\lambda^{(3)}$  type diffraction was obtained for pulses with one-two oscillations under the envelope.

#### References:

[1] N. Naumova, J. Nees, I. Sokolov, B. Hou and G. Mourou, “Relativistic Generation of Isolated Attosecond Pulses in focal volume”, *Phys. Rev. Lett.*, 92(6), 063902, (2004)

[2] A. M. Dakova, L. M. Kovachev, K. L. Kovachev, D. Y. Dakova, “Fraunhofer-type diffraction of phase-modulated broad-band femtosecond pulses”, *Journal of Physics: Conference Series*, 594, 012023, (2015)

**Acknowledgements:** The present work is funded by the Bulgarian National Science Fund by Grant No KP-06-H58/8-2021 and the National Roadmap for Research Infrastructure, Bulgaria “Extreme Light” ELI-ERIC Consortium under contract D01-351/13.12.2023.

## P.E6

### EFFICIENCY OF THE ENERGY EXCHANGE PROCESS DURING FOUR-WAVE MIXING UNDER THE INFLUENCE OF SELF-PHASE MODULATION AND CROSS-PHASE MODULATION

Zara Kasapeteva<sup>1,2</sup>, Aneliya Dakova<sup>1,3</sup>, Valeri Slavchev<sup>1,4</sup>, Diana Dakova<sup>2</sup>

<sup>1</sup>*Nonlinear and Fiber Optics, Institute of Electronics, Bulgarian Academy of Sciences, 72 Tsarigradsko Chaussee, 1784 Sofia, Bulgaria*

<sup>2</sup>*Faculty of Mechanical Engineering, Technical University Sofia - Plovdiv Branch, 25 Tzanko Diustabanov Str., 4000, Plovdiv, Bulgaria*

<sup>3</sup>*Faculty of Physics and Technology, Paisii Hilendarski University of Plovdiv, 24 Tsar Asen Str., 4000 Plovdiv, Bulgaria*

<sup>4</sup>*Faculty of Pharmacy, Medical University - Plovdiv, 15 Vasil Aprilov Blvd., 4002 Plovdiv, Bulgaria*

email: [zarra\\_andreeva@abv.bg](mailto:zarra_andreeva@abv.bg)

In numerous scientific works, the process of four-wave mixing (FWM) has been theoretically investigated without and with consideration of the effects of self-phase modulation (SPM) and cross-phase modulation (CPM) in CW regime of propagation of laser radiation. The parametric interaction between three waves (pumping, signal and idler), evolving in an isotropic nonlinear Kerr-type medium is taken into account.

The solutions of the corresponding systems of equations describing the parametric FWM are represented by the Jacobi elliptic sine function  $\text{sn}(z,k)$ , where  $k$  is the modulus of ellipticity. This is a periodical function and it is known as a cnoidal wave. Its period is represented by the function complete elliptic integral of the first kind.

In the present work, the period of the parametric energy exchange between the three waves is investigated. The corresponding periods are compared in the cases with and without taking into account the effects of SPM and CPM. It is shown that the consideration of the two processes

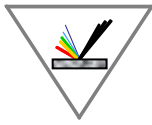

leads to an increase in the period of energy exchange between the pumping, signal and idler waves propagating in nonlinear Kerr-type medium. It is important to mention that the process of energy exchange between the three waves can be controlled by changing the initial value of the generalized phase.

## P.E7

### GENERATION OF AMPLITUDE VORTICES IN ISOTROPIC NONLINEAR MEDIA

Valeri Slavchev<sup>1,2</sup>, Aneliya Dakova-Mollova<sup>1,3</sup>, Zara Kasapeteva<sup>1,4</sup>, Kamen Kovachev<sup>1</sup>,  
Diana Dakova<sup>3</sup>, Lubomir Kovachev<sup>1</sup>

<sup>1</sup>*Institute of Electronics, Bulgarian Academy of Sciences, 72 Tsarigradsko Chaussee,  
1784 Sofia, Bulgaria*

<sup>2</sup>*Department of Medical Physics and Biophysics, Faculty of Pharmacy, Medical University -  
Plovdiv, 15 Vasil Aprilov Blvd, 4002 Plovdiv, Bulgaria*

<sup>3</sup>*Physics and Technology Faculty, Paisii Hilendarski University of Plovdiv, 24 Tsar Asen Str.,  
4000 Plovdiv, Bulgaria*

<sup>4</sup>*Faculty of Mechanical Engineering, Technical University Sofia- Plovdiv Brach,  
25 Tzanko Diustabanov Str. 4000 Plovdiv, Bulgaria*

email: [valerislavchev@yahoo.com](mailto:valerislavchev@yahoo.com)

In recent years, the study of optical vortex structures characterized by an amplitude-type singularity, or the so-called polarization vortices, has been particularly relevant. The specific about them is that they can be observed only in the intensity components of the laser radiation. Their stability is a result of the balance between diffraction and nonlinearity, as well as nonlinearity and angular distribution. The dynamic of these vortex structures in isotropic media is described by the vector nonlinear amplitude equation. They are investigated in the frames of a system of two scalar nonlinear amplitude equations for the  $x$  and  $y$  components of the vector electric field. Depolarization is observed in the vector field in the laser spot for these singularities. These optical vortices can be created outside the laser cavity by using optical elements.

The peculiarities of their evolution open up new opportunities for their potential application in a number of modern technologies, such as quantum information transfer, data encryption, high-resolution laser microscopy, optical tweezers, and many others.

*Keywords:* Vortex structures, polarization vortices, depolarization, vector amplitude function

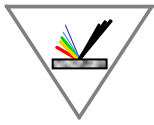

## P.E8

### DIRAC REPRESENTATION OF NONLINEAR MAXWELL EQUATIONS

D. A. Georgieva<sup>1,2</sup>, L. M. Kovachev<sup>2</sup>

<sup>1</sup>*Faculty of Applied Mathematics and Informatics, Technical University of Sofia, 8 Kliment Ohridski Blvd, 1000 Sofia, Bulgaria*

<sup>2</sup>*Institute of Electronics, Bulgarian Academy of Sciences, 72 Tsarigradsko Chaussee, 1784 Sofia, Bulgaria*

*email: [dgeorgieva@tu-sofia.bg](mailto:dgeorgieva@tu-sofia.bg)*

The standard procedure for obtaining a system of amplitude equations in nonlinear optics is to start from the vector nonlinear integro-differential wave equation and to use an approximation up to second-order of linear dispersion and first-order of nonlinear dispersion. A more precise analysis requests to start directly from nonlinear Maxwell system of equations to obtain amplitude equations of the electrical and the magnetic field. In this presentation, we will show that using an appropriate combination of circular and linear polarization of the field components, the nonlinear Maxwell system of amplitude equations is equivalent to a nonlinear Dirac system of equations. The obtained solutions with half-integer spin in Dirac representation correspond to localized dark states in Maxwell form with circular Poynting vector.

#### References:

[1] W. Heisenberg, “Zur Quantentheorie nichtrenormierbarer Wellengleichungen”, Zs. Naturforsch., 9a, 292-303, (1954)

[2] L. M. Kovachev, “Vortex solutions of the Nonlinear Optical Maxwell-Dirac Equations”, Physica D-Nonlinear Phenomena, 190, 78-92, (2004)

**Acknowledgements:** The present work is funded by the Bulgarian National Science Fund by Grant № KP-06-H58/8-2021 and the National Roadmap for Research Infrastructure, Bulgaria “Extreme Light” ELI-ERIC Consortium under contract D01-351/13.12.2023.

## P.E9

### DARK SPATIAL SOLITONS IN ALKALI METAL VAPOR

Nikola Nikolov, Stoyan Tsvetkov, Sanka Gateva

*Institute of Electronics, Bulgarian Academy of Sciences, 72 Tsarigradsko Chaussee Blvd., 1784 Sofia, Bulgaria*

*e-mail: [ninikolov@ie.bas.bg](mailto:ninikolov@ie.bas.bg)*

Spatial effects, such as self-lensing (self-focusing for blue-detuned or self-defocusing for red-detuned resonant laser beams), self-trapping and others have been of constant interest for a long time [1-7]. It was shown that nonlocal response of the nonlinear medium can lead to stabilization of transverse bright solitary beams in the self-focusing case in sodium vapor [2]. Different nonlinear mechanisms for self-lensing in atomic vapors [5], and two different mechanisms that contribute to nonlocality of the nonlinearity, i.e. atomic(thermal) and radiation diffusion [4] have been studied.

Propagation of spatial dark solitons in atomic vapors have been predicted, but to our knowledge, not yet studied either numerically or observed experimentally.

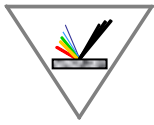

Here we study the possibility to form and propagate spatial dark solitons in rubidium vapor and the possibility to form bound states of transverse dark solitary waves.

#### References:

- [1] J. E. Bjorkholm and A. A. Ashkin, “CW self-focusing and self-trapping of light in sodium vapor”, *Phys. Rev. Lett.*, 32, 129, (1974)
- [2] D. Suter and T. Blasberg, “Stabilization of transverse solitary waves by a nonlocal response of the nonlinear medium”, *Phys. Rev. A*, 48, 4583, (1993)
- [3] T. Scholz, M. Schiffer, J. Welzel, D. Cysarz and W. Lange, “Spatial effects of radiation trapping in an optically thick atomic vapor excited by a laser beam”, *Phys. Rev. A*, 53, 2169, (1996)
- [4] T. Ackemann, T. Scholz, Ch. Vorgerd, J. Nalik, L.M. Hoffer and G.L. Lippi, “Self-lensing in sodium vapor: influence of saturation, atomic diffusion and radiation trapping”, *Optics Communications*, 147(4–6), 411-428, (1998)
- [5] G. Labeyrie, G. L. Gattobigio, T. Chanelière, G. L. Lippi, T. Ackemann and R. Kaiser, “Nonlinear lensing mechanisms in a cloud of cold atoms”, *Nonlinear Dynamics*, 41, 337-348, (2007)
- [6] E. Shahmoon, P. Grišins, P. H. Stimming, I. Mazets and G. Kurizki, “Highly nonlocal optical nonlinearities in atoms trapped near a waveguide”, *Optica*, 3(7), 725, (2016)
- [7] Q. Glorieux, T. Aladjidi, P. D. Lett and R. Kaiser, “Hot atomic vapors for nonlinear and quantum optics”, *New J. of Phys.*, 25, 5, 051201, (2023)

## P.E10

### GOUY PHASE OF VORTEX NECKLACE AND ANNIHILATED VORTEX BEAMS

Edmon Lazarov<sup>1</sup>, Lyubomir Stoyanov<sup>1</sup>, Maria Mincheva<sup>1</sup>, Petko Drenkov<sup>1</sup>, Nasko Gorunski<sup>1</sup>,  
Alexander Dreischuh<sup>1</sup>

<sup>1</sup>*Department of Quantum Electronics, Faculty of Physics, St. Kliment Ohridski  
University of Sofia, 5 James Bourchier Blvd., 1164 Sofia, Bulgaria*

*email: [l.stoyanov@phys.uni-sofia.bg](mailto:l.stoyanov@phys.uni-sofia.bg)*

Optical vortices (OVs) are dark beams carrying spiral phase dislocations in their wavefronts, which also determine the intensity structure of the beams – the characteristic doughnut-shape intensity profiles [1]. The angular momentum they carry is related to the topological charge (TC)  $l$ , which corresponds to the total phase change  $2\pi l$  over the azimuthal coordinate  $\varphi$  [2]. If two OVs with equal TCs are placed on a common background beam they will exhibit repulsion similar to electrical charges with same signs. Alternatively, OVs with TCs with different signs will attract each other and eventually annihilate. When OVs with low TCs are annihilated and subsequently Fourier transformed (focused by a thin lens), Gaussian beam is recovered in the beam waist [3].

On the other hand, multiple OVs of the same TCs can be arranged in circular structures with respect to the beam axis forming a vortex necklace beam. Besides the option to control the radius of the necklace structure, we can also control the number of the OVs in the structures. When focused, in the focal plane of a lens a well-defined central peak is observed again.

The Gouy phase shift is an additional phase change that a laser beam undergoes as it passes through its focus, amounting to a total phase shift of  $\pi$  radians for a pure Gaussian beam. Understanding the Gouy phase is crucial in applications involving laser beam focusing, where

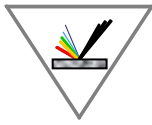

precise control of the beam's phase and amplitude is essential [4,5]. In this work, we study the Gouy phase of annihilated vortex beams (Fig. 1, Case A) and for vortex necklace beams (Fig. 1, Case B) using the single lens interferometric technique [6] and the options to control it.

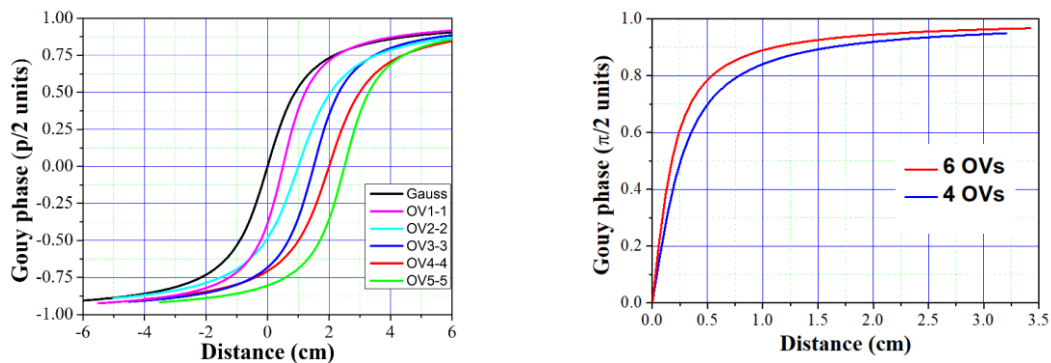

**Fig. 1. Left:** Gouy phase for Case A. **Right:** Gouy phase for Case B. (see text for details).

#### References:

- [1] A. S. Desyatnikov, et al., “Optical vortices and vortex solitons”, *Progress in Optics*, 47, 291-391, (2005)
- [2] H. He et al., “Direct observation of transfer of angular momentum to absorptive particles from a laser beam with a phase singularity”, *Phys. Rev. Lett.*, 75, 826-829, (1995)
- [3] L. Stoyanov, et al., “Far field diffraction of an optical vortex beam by a fork-shaped grating”, *Optics Communications*, 350, 301-308, (2015)
- [4] E. H. Linfort, E. Wolf, “Phase distribution near focus in an aberration-free diffraction image”, *Proc. Phys. Soc., London, Sect. B*, 69(8), 823-832, (1956)
- [5] S. Feng, H. G. Winful, “Physical origin of the Gouy phase shift”, *Opt. Lett.*, 26 (8), 485-487, (2001)
- [6] J. Peatross, M. V. Pack, “Visual introduction to Gaussian beams using a single lens as an interferometer”, *Am. J. Phys.*, 69(11), 1169-1172, (2001)

**Acknowledgements:** This work was funded by the Bulgarian National Science Fund (project KII-06-H78/6). L.S. gratefully acknowledges the Return Grant awarded by the Alexander von Humboldt Foundation.

## P.E11

### GOUY PHASE DETERMINATION OF EVEN HERMITE-GAUSSIAN LASER MODES USING SINGLE-LENS INTERFEROMETER

Maria Mincheva<sup>1</sup>, Petko Drenkov<sup>1</sup>, Edmon Lazarov<sup>1</sup>, Nasko Gorunski<sup>1</sup>, Lyubomir Stoyanov<sup>1</sup>, Alexander Dreischuh<sup>1</sup>

<sup>1</sup>*Department of Quantum Electronics, Faculty of Physics, St. Kliment Ohridski University of Sofia, 5 James Bourchier Blvd., 1164 Sofia, Bulgaria*

*email: [mariaquantum2@gmail.com](mailto:mariaquantum2@gmail.com)*

It is known that any focused light-beam experiences an axial phase shift with respect to a reference plane wave when passing through its focus. This phase anomaly was first studied by Gouy and is named after him. The chronology of early studies can be found in [1]. Later, most of the research was related to the development of microwave optics, lasers, nonlinear optics, terahertz radiation, and singular optics, to mention just a few.

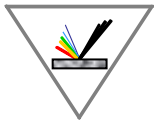

XXIII International Conference and School on Quantum Electronics:  
“Laser Physics and Applications”

The Gouy phase is related to the axial phase shift experienced by any focused light-beam with respect to a reference plane wave when passing through its focus. Let us denote by  $L_D$  and  $z$  the Rayleigh diffraction length of a Gaussian beam and the longitudinal coordinate, respectively. Then, the Gouy phase for a Gaussian beam is given by  $\Phi_G = \text{atan}(z/L_D)$ . Generally, the Gouy phase  $\Phi_G$  for a higher-order Hermite-Gaussian (HG) beam is this for the fundamental Gaussian beam multiplied by a factor, which is the sum of the mode indices of the HG beam plus unity ( $1+l+m$ , where  $l$  and  $m$  are the mode indices) [2].

Although this result is a paradigm in optics, we are not aware of its experimental verification. In this poster, we present experimental results (see Fig. 1 below) obtained with a single-lens interferometer for higher-order HG modes generated using spatial light modulator. The retrieved Gouy phase  $\Phi_G$  is found in a very good quantitative agreement with the mentioned theoretical result.

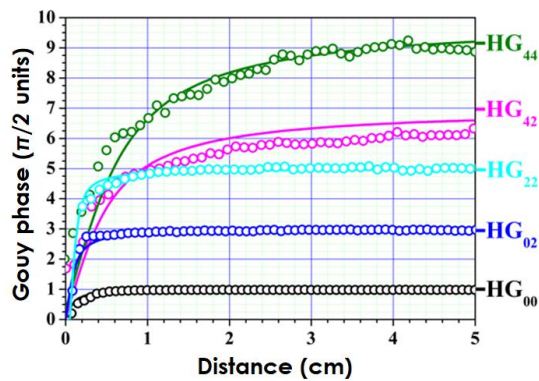
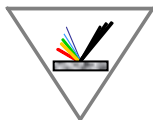

**Fig. 1.** Gouy phases (in  $\pi/2$  units) for five symmetrical HG modes vs. propagation distance from the focal plane. Hollow circles – data retrieved from the experiment. Solid curves – theoretical approximations.

**References:**

- [1] E. H. Linfoot and E. Wolf, “Phase distribution near focus in an aberration-free diffraction image”, Proc. Phys. Soc., London, Sect. B, 69(8), 823–832, (1956)
- [2] S. Feng and H. G. Winful, “Physical origin of the Gouy phase shift”, Opt. Lett., 26(8), 485–487, (2001)

**Acknowledgements:** This work was funded by the Bulgarian National Science Fund (project KP-06-N78/6).



## P.F1

### SOME INITIAL RESULTS ON SYNTHESIS OF NANOPARTICLES FROM BaTiO<sub>3</sub> BY PULSED LASER ABLATION IN LIQUID MEDIA

Ivaylo Balchev\*<sup>1</sup>, Nadya Stankova<sup>1</sup>, Dimitar Dimov<sup>1</sup>, Desislava Karaivanova<sup>1</sup>, Maria Gancheva<sup>2</sup>, Reni Iordanova<sup>2</sup>, Georgi Avdeev<sup>3</sup>, Kaloyan Genkov<sup>4</sup>, Anton Zyapkov<sup>4</sup> and Teodor Milenov<sup>1</sup>

<sup>1</sup>*Institute of Electronics, Bulgarian Academy of Sciences, 72 Tsarigradsko Chaussee Blvd, 1784 Sofia, Bulgaria*

<sup>2</sup>*Institute of General and Inorganic Chemistry, Bulgarian Academy of Science, Acad. G. Bonchev Str, bl.11, 1113 Sofia, Bulgaria*

<sup>3</sup>*Institute of Physical Chemistry, Bulgarian Academy of Science, Acad. G. Bonchev Str, bl.11, 1113 Sofia, Bulgaria*

<sup>4</sup>*Faculty of Physics, St. Kliment Ohridski University of Sofia, J. Bouchier Blvd 5, 1164 Sofia, Bulgaria*

*e-mail: [karaivanova1888@abv.bg](mailto:karaivanova1888@abv.bg)*

Nano and micro-sized particles are expected to provide solutions for a variety of applications in electronics, optics and biomedicine. The aim of this study is synthesizing nano-sized BaTiO<sub>3</sub> (BTO) particles by pulsed laser ablation (PLA). The BTO target was obtained by initial mechano-chemical treatment of BaCO<sub>3</sub> and rutile powders and further high-temperature solid-state synthesis. The BTO targets were characterized by powder X-ray diffraction (XRD).

The PLA processes were carried out by irradiation using a Nd:YAG nanosecond laser at various wavelengths (266 – 1064 nm) and laser-beam intensities. Several techniques – XRD, UV-Vis absorption spectroscopy (UV-Vis) and scanning electron microscopy with energy dispersive X-ray analysis (SEM/EDX), were employed to characterize the phase composition, optical properties, particle morphology and size.

**Acknowledgements:** The authors gratefully acknowledge the financial support of the Bulgarian National Science Fund by grant No KP 06-H77/13.



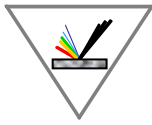

## P.F2

### MODIFICATION OF THE STRUCTURE AND COMPOSITION OF TANTALUM OXYNITRIDE COATINGS DEPENDING ON THE DEPOSITION CONDITIONS

N. Donkov<sup>1</sup>, A. Zykova<sup>2,3</sup>, V. Safonov<sup>2,3,4</sup>, S. Dudin<sup>3</sup>, S. Yakovin<sup>3</sup>, M. Sawczak<sup>4</sup> and G. Kolev<sup>5</sup>

<sup>1</sup>*Institute of Electronics, Bulgarian Academy of Sciences, 72 Tsarigradsko Chaussee, 1784 Sofia, Bulgaria*

<sup>2</sup>*Kharkov Institute of Physics and Technology National Science Center 1 Academicheskaya Str., 61108 Kharkiv, Ukraine*

<sup>3</sup>*V.N. Karazin Kharkiv National University, 4 Svobody Sq., 61022 Kharkiv, Ukraine*

<sup>4</sup>*Szewalski Institute of Fluid-Flow Machinery of the Polish Academy of Sciences Gdansk, Poland*

<sup>5</sup>*University of Chemical Technology and Metallurgy, 8 Kliment Ohridski Blvd., 1756 Sofia, Bulgaria*

email: [nikolaidd@abv.bg](mailto:nikolaidd@abv.bg)

The metal oxynitrides are a class of novel multifunctional materials whose properties can be varied in wide ranges by controlling the concentration ratio of N and O atoms in the material. Changing the atomic O/N ratio affects the mechanical, electrochemical and biological properties. Also, the oxynitrides present a large array of modifications in the structural and elemental composition depending on the conditions of deposition. The TaON structures combine the characteristics exhibited by tantalum nitride, which is used as a hard material for tribological and mechanical applications, with the high dielectric properties of the tantalum oxide. The aim of this work was to study the effect of the deposition conditions on the structure and properties of oxynitride (TaON) coatings in view of possible multifunctional applications.

Coatings of tantalum oxynitride were deposited by means of reactive-ion magnetron sputtering. The chemical composition was modified by changing the flow of reactive gases oxygen and nitrogen. The characteristics of the oxynitride coating deposition process were as follows: a tantalum target with a diameter of 170 mm; base pressure of the vacuum system of about  $1 \times 10^{-3}$  Pa; Ar pressure of  $6.5 \times 10^{-2}$  Pa; total mass flow-rate of oxygen and nitrogen of 60 sccm with varying oxygen-nitrogen ratio; total pressure of about  $1 \times 10^{-1}$  Pa; magnetron voltage of 610 V and magnetron current of 6.5 A. The samples' surface was cleaned prior to deposition by an ion source. The thickness of the coatings was  $\sim 2 \mu\text{m}$  as estimated by a Calotest device.

The films' material characterizations included X-ray diffraction on Shimadzu XRD-6100 diffractometer for identifying crystal structures, scanning electron microscope (SEM JSM-7100F) for observing surface morphologies, energy-dispersive X-ray spectroscopy (EDX Oxford Link ISIS 300) for elemental composition evaluation. To identify the vibrational modes of TaON microstructures, Raman spectroscopy was carried out using a micro-Raman system (InVia, Renischaw) operating with a 514 nm argon ion laser as an excitation source. Moreover, coatings of tantalum oxynitride were studied by a Thermo Scientific Nicolet iS10 FTIR spectrometer equipped with attenuated total reflectance (ATR) accessory to identify functional groups present in TaON, such as Ta-N and Ta-O bonds. This information can be used to understand the electronic and structural properties of the material, which may be important for its potential multifunctional applications.

The results demonstrate that significant changes in the structure and chemical composition of tantalum oxynitride arise depending on the deposition conditions and the ratio of reactive gases

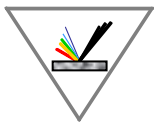

in a N<sub>2</sub>/O<sub>2</sub> mixture at a constant total flow-rate. Overall, comparative analyses of IR and Raman spectra of TaON coatings together with results of XRD and EDX can provide valuable information on their composition and structural characteristics, and can also be used to optimize their properties for various applications.

**Acknowledgements:** The work was supported under the international scientific cooperation agreement between the Bulgarian and Ukrainian National Academies of Sciences and by the European Union-NextGenerationEU, through the National Recovery and Resilience Plan of the Republic of Bulgaria, project № BG-RRP-2.004-0002, "BiOrgaMCT".

## P.F3

### LINEAR AND BRANCHED HYDROPHILIC BLOCK COPOLYMERS DESIGNED FOR THIN-FILM OPTICAL SENSING APPLICATIONS

Katerina Lazarova<sup>1</sup>, Sijka Ivanova<sup>2</sup>, Darinka Christova<sup>2</sup> and Tsvetanka Babeva<sup>1</sup>

<sup>1</sup>*Acad. J. Malinowski Institute of Optical Materials and Technologies, Bulgarian Academy of Sciences, Acad. G. Bonchev Str., bl. 109, 1113 Sofia, Bulgaria*

<sup>2</sup>*Institute of Polymers, Bulgarian Academy of Sciences, Acad. G. Bonchev Str, bl. 103-A, 1113 Sofia, Bulgaria*

*e-mail: [klazarova@iomt.bas.bg](mailto:klazarova@iomt.bas.bg)*

In this research, a novel design is proposed and studied of vapor sensing thin-film devices based on poly(N,N-dimethyl acrylamide) (PDMA) macromolecular architectures. Series of hydrophilic PDMA copolymers with different chemical composition and structure were synthesized and characterized in terms of thin-film humidity sensing – a linear triblock copolymer with a middle poly(ethylene oxide) block (PDMA-b-PEO-b-PDMA), a three-arm star-shaped PDMA copolymer, as well as similar branched triblock copolymer structures with different crosslink segments. Proper conditions for spin-coating deposition of thin films with excellent optical quality were found. The refractive index and the extinction coefficient of the thin-film sensitive polymer materials were calculated from reflectance spectra. The changes in the reflectance were studied during humidity alteration in the range 5 – 95% RH. It was demonstrated that the chemical structure and composition, as well as the macromolecular architecture of the copolymers play a crucial role in their optical and sensing properties. Humidity sensing experiments in changing humidity ambience showed that the macromolecular structure affects both the sensitivity (S) and the degree of hysteresis (H) of the materials. The most suitable polymer for optical humidity reading was determined showing optimal balance between S and H.

**Acknowledgements:** Research equipment of Distributed Research Infrastructure INFRAMAT, part of the Bulgarian National Roadmap for Research Infrastructures, supported by Bulgarian Ministry of Education and Science was used in this investigation.

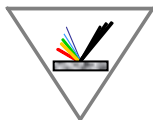

## P.F4

### PREPARATION OF IMPROVED CERIA CONVERSION COATINGS (CECC) FOR CORROSION PROTECTION OF Al 1050 ALLOY

Reni Andreeva<sup>1</sup>, Aleksandar Tsanev<sup>2</sup> and Dimitar Stoychev<sup>1</sup>

<sup>1</sup>*Rostislav Kaischew Institute of Physical Chemistry, Bulgarian Academy of Sciences,  
Acad. Georgi Bonchev Street, bl. 11, 1113 Sofia, Bulgaria*

<sup>2</sup>*Institute of General and Inorganic Chemistry, Bulgarian Academy of Sciences,  
Acad. Georgi Bonchev Street, bl. 11, 1113 Sofia, Bulgaria*

*e-mails: [randreeva@ipc.bas.bg](mailto:randreeva@ipc.bas.bg), [stoychev@ipc.bas.bg](mailto:stoychev@ipc.bas.bg), [tsanew@abv.bg](mailto:tsanew@abv.bg)*

We developed a procedure for preparation of improved ecologically-friendly ceria conversion coatings (CeCC) for corrosion protection of anodized Al 1050 alloys. The benefits of the preparation procedure used are its simplicity and low cost. The coatings are obtained by consecutive sealing treatments of anodized Al 1050 in cerium containing and mixed  $\text{NaH}_2\text{PO}_4 + \text{Ca}(\text{NO}_3)_2$  solutions. The improvement of these layers compared to those obtained in our previous experiments [1] is the addition of  $\text{Ca}(\text{NO}_3)_2$  to the solutions.

The changes of the surface morphology, structure and chemical composition, the chemical state of the elements, as well as the basic corrosion parameters of the studied systems were investigated by SEM, EDS, XRD, XPS and a complex of electrochemical techniques – potentiodynamic polarization, (PDP),  $E_{\text{ocp}}$  vs. time plot, chronoamperometric transients,  $R_p$  and CR at EOCp, etc. The results obtained show that the basic components of the obtained conversion layers (before and after exposure in model  $\text{Cl}^-$ -containing corrosion media) are  $\text{Ca}_{10}(\text{PO}_4)_6(\text{OH})_2$ ,  $\text{AlO}(\text{OH})$ ,  $\text{CePO}_4$  and  $\text{CeAlO}_3$  (after the corrosion tests they convert to insoluble  $\text{Me-PO}_3$  and  $\text{Me-P}_4\text{O}_{10}$ ). These chemical compounds are insoluble and they fill up the Alanod-pores during the two-step sealing treatment. The formation of the insoluble conversion coatings on the surface of the Alanod leads to a strong increase of the polarization resistance and a decrease of the corrosion rate of Al. Based on these results, we established the optimal conditions for sealing immersion treatment(s) of Alanod leading to a strong increase of its corrosion resistance. Moreover, The PDP tests showed that the sealing layers formed are not only static barrier coatings, but they also change the kinetics of the conjugate cathode and anode electrochemical reactions characterizing the corrosion process, i.e. they also determine the electrochemical protection.

#### References:

[1] A. Tsanev, R. Andreeva, D. Stoychev, “Influence of the Chemical Composition of Ceria Conversion Coatings Sealed in Solution of  $\text{NaH}_2\text{PO}_4$  and  $\text{Ca}(\text{NO}_3)_2$ , on the Corrosion Behavior of Aluminum”, *Materials*, 16, 6499, (2023)

**Acknowledgements:** This work is financially supported by the National Infrastructure SI ESHER (NI SEVE) project supported by the Bulgarian Ministry of Education and Science under grant agreement DO1- 349/ 13.12.23.

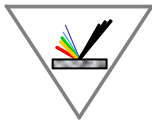

## P.F5

### WIRE ARC DEPOSITION OF SPECIMENS USING ALUMINUM WELDING WIRE WITH Al-C COMPOSITE FLUX CORE

G. Kotlarski<sup>1,\*</sup>, M. Ormanova<sup>1</sup>, A. Nikitin<sup>2</sup>, R. Ossenbrink<sup>2</sup>, N. Doynov<sup>2,3</sup>, S. Valkov<sup>1,4</sup>,  
V. Michailov<sup>2</sup>

<sup>1</sup>*Institute of Electronics, Bulgarian Academy of Sciences, 72 Tsarigradsko Chaussee,  
1784 Sofia, Bulgaria*

<sup>2</sup>*Department of Joining and Welding Technology, Brandenburg University of Technology,  
Platz der Deutschen Einheit 1, 03046 Cottbus, Germany*

<sup>3</sup>*Institute of Metal Science, Equipment and Technologies with Center for Hydro- and  
Aerodynamics, Bulgarian Academy of Sciences, 67 Shipchenski prohod Blvd.,  
1574 Sofia, Bulgaria*

<sup>4</sup>*Faculty of Mathematics, Informatics, and Natural Sciences, Technical University of  
Gabrovo, 4 H Dimitar Str., 5300 Gabrovo, Bulgaria*

*e-mail: [gvkotlarski@gmail.com](mailto:gvkotlarski@gmail.com)*

In this work, the possibility was studied of wire arc additive manufacturing of components using an aluminum welding wire with an Al-C flux core. The appropriate technological conditions of layer deposition were selected for the successful manufacturing of a wall-shaped specimen. The latter was built using a multi-track approach. The structure of the specimen was studied using X-ray diffraction (XRD), scanning electron microscopy (SEM), and energy-dispersive X-ray diffraction (EDX). The mechanical properties, particularly the microhardness of the specimen, was studied along its cross-section. Additionally, the level of porosity within the volume of the specimen was studied and determined using the Archimedes method for porosity measurement.

The results indicated the presence of a large quantity of pores up to over 40% within the volume of the specimen. Regardless of the high defect density within the specimen, a number of integrated carbon particles were detected in certain areas of the cross-section of the specimen. In those zones, the microhardness of the specimen increased, which can be explained by the artificial strengthening of the aluminum matrix. This proves that improving the mechanical properties of aluminum specimens using carbon nano-structures is indeed possible and a viable solution; however, the wire preparation process and the deposition conditions both need to be further optimized.

**Acknowledgements:** This work was supported by the Bulgarian National Science Fund, grant number KP 06-DO 02/1 (2019).

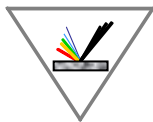

## P.F6

### PREPARATION OF RGO AND COMPOSITES BY CLASSICAL AND ALTERNATIVE REDUCING AGENTS

D. Kichukova, Ts. Lazarova, G. Atanasova, D. Kovacheva, I. Spassova

*Institute of General and Inorganic Chemistry, Bulgarian Academy of Sciences,  
1113 Sofia, Bulgaria*

*e-mail: [genoveva@svr.igic.bas.bg](mailto:genoveva@svr.igic.bas.bg)*

A new-generation of carbon materials (graphene, fullerenes, carbon nanotubes, etc.) in nanocomposites combine many advantages, such as flexibility, durability, hydrophobicity, possibility of subsequent functionalization with mechanical and thermal stability. Graphene is receiving increasing attention due to its unique physical properties, such as high mechanical strength, high Young's modulus, high breaking strength, and good optical properties. The reduced graphene oxide (RGO) is also known as chemically modified graphene, functionalized graphene, chemically converted graphene, or simply graphene. When chemically prepared, the RGO has some residual oxygen functional groups remaining after the incomplete reduction of graphene sheets. Various graphene composites with the participation of polymers, semiconductors, metals, metal oxides, sulfides, alloys, organic materials, etc. have been studied. In graphene composites, graphene can act either as a functional component or as a substrate for immobilizing the other components. Graphene-based nanocomposites are very promising for producing sensor devices, due to graphene's large specific surface area, high reactivity, and biocompatibility. It is an excellent candidate for developing low-cost sensors on flexible substrates.

Various soft reducing agents were tested to prepare RGO by a chemical approach from previously prepared graphene oxide (GO). Glycerol, ethylene glycol, and citric acid did not reduce GO, and the use of sucrose, acetic acid, and oxalic acid resulted in incomplete reduction of GO. The use of urea, L-ascorbic acid, and glycine leads to the removal of intermediate functional groups in GO, and the complete reduction is achieved when using L-ascorbic acid and glycine. Depending on the type of reducing agent, the morphological properties of the obtained RGO are different. The application of L-ascorbic acid leads to a more compact packing of the RGO layers, while with glycine more dispersed sheets are formed with the presence of voids between them.

Two simple one-step methods for successfully preparing RGO-based composites with various concentrations of copper and silver were applied using the classical  $\text{NaBH}_4$  and the alternative  $\text{H}_2$  reducing agents. Good exfoliation of the carbon layers was observed for all samples. An almost uniform distribution of copper and silver metal nanoparticles on the graphene layers was observed. The metal nanoparticles are on the surface and at the edges of the layers. Combining the SEM, TEM, and XRD results, it can be seen that larger Ag crystallites combine into smaller aggregates, while smaller Cu crystallites tend to aggregate into larger particles. The XPS confirms different carbon bonds typical of RGO. The copper-containing composite shows a particularly oxidized surface of Cu nanoparticles, while in the case of the silver composite, the XPS and Auger spectra of silver are consistent with metallic silver.

The prepared nanocomposites show excellent antibacterial properties and high cytotoxicity.

**Acknowledgements:** This research was funded by the Bulgarian Scientific Fund, Project KP-06-H 59/8 “Porous 3D graphene-based hierarchical materials for environmental protection”.

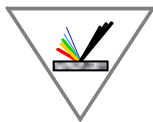

## P.F7

### SOME INITIAL RESULTS ON FORMATION OF Si-O-C GLASSES DURING THE DIRECT CARBONIZATION OF Si SUBSTRATES - XPS AND GDOES STUDIES

I. Avramova<sup>1</sup>, I. Zahariev<sup>2</sup>, V. Mehandziev<sup>3</sup>, B. Blagoev<sup>3</sup>, P. Rafailov<sup>3</sup>, G. Avdeev<sup>2</sup>,  
D. Karashanova<sup>4</sup>, B. Georgieva<sup>4</sup>, S. Kolev<sup>5</sup>, D. Dimov<sup>5</sup> and T. Milenov<sup>5</sup>

<sup>1</sup>*Institute of General and Inorganic Chemistry, Bulgarian Academy of Sciences, Acad. G. Bonchev Str., bl. 11, 1113 Sofia, Bulgaria*

<sup>2</sup>*Acad. Rostislav Kaishev Institute of Physical Chemistry, Bulgarian Academy of Sciences, Acad. G. Bonchev Street, bl. 11, 1113 Sofia, Bulgaria*

<sup>3</sup>*G. Nadjakov Institute of Solid State Physics, Bulgarian Academy of Sciences, 72 Tsarigradsko Chaussee, 1784 Sofia, Bulgaria*

<sup>4</sup>*Acad. Jordan Malinowski Institute of Optical Materials and Technologies, Bulgarian Academy of Sciences, Acad. G. Bonchev Street, bl. 109, 1113 Sofia, Bulgaria*

<sup>5</sup>*Acad. E. Djakov Institute of Electronics, Bulgarian Academy of Sciences, 72 Tsarigradsko Chaussee, 1784 Sofia, Bulgaria*

*e-mail: [iva@svr.igic.bas.bg](mailto:iva@svr.igic.bas.bg)*

Silicon carbide, with its superior physical and chemical properties, has been considered a versatile material for a broad range of applications, including high-power electronics, high-temperature sensors, and bio sensing devices.

The thin SiC layers were deposited by chemical vapor deposition (CVD) in an Oxford Nanofab Plasmalab System 100 apparatus on {111} Si substrates. The X-ray photoelectron spectroscopy (XPS) depth profiles were obtained by sputtering by an Ar beam and monitoring the changes in the surface composition and chemical state of the elements of interest (C, O and Si). These depth profiles were produced by selecting only the peaks of interest, and then sequentially sputtering by the Ar gun for a fixed duration followed by analysis of the elements of interest. At each sputtering, the recorded C1s O1s and Si2p photoelectron spectra were fitted; as a result, a similar evolution of the components' depth profiles was found. Ultra-fast elemental depth profile analysis was conducted by using glow-discharge optical emission spectroscopy (GDOES) accomplished by a Spectrum Analytic GDA 750 HR. Transmission electron microscopy (TEM) studies were performed on an HR STEM JEOL 2100 microscope.

The results indicate the formation of SiC in all films. Nevertheless, a small amount of oxygen is present in all films. The incorporation of most of the oxygen into the SiC thin films is thus not associated with the formation of silicon oxycarbide.

**Acknowledgements:** The authors gratefully acknowledge financial support from the National Science Fund of Bulgaria under Grant KP-06-H58/2-16.11.2021. Research equipment of Distributed Research Infrastructure INFRAMAT, part of the Bulgarian National Roadmap for Research Infrastructures, supported by the Bulgarian Ministry of Education and Science was used in this investigation.

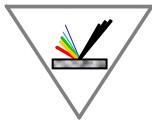

## P.F8

### DESIGN AND ELABORATION OF A MULTILAYER MIRROR FOR A LIDAR SYSTEM

A. Tenev<sup>1</sup>, E. Stoyanova<sup>1</sup>, I. Miloushev<sup>1</sup>, T. Tenev<sup>1</sup>, K. Shumanov<sup>2</sup>, I. Grigorov<sup>2</sup>

<sup>1</sup>*Institute of Solid State Physics, Bulgarian Academy of Sciences, 72 Tsarigradsko Chaussee, 1784 Sofia, Bulgaria*

<sup>2</sup>*Institute of Electronics, Bulgarian Academy of Sciences, 72 Tsarigradsko Chaussee, 1784 Sofia, Bulgaria*

*e-mail: [alexander.tenev@gmail.com](mailto:alexander.tenev@gmail.com)*

A multilayer dielectric mirror for laser radiation with a beam diameter of 120 mm was developed and implemented. The laser radiation is continuous with wavelengths of 510.6 and 593 nm (copper bromide vapor laser), falls on the mirror at an angle of 45 degrees and is deflected by 90 degrees in the vertical direction. The mirror has a reflection of not less than 95% under the conditions listed above, is resistant to non-intense external influences and can work in an open atmospheric environment. It is used to expand the capabilities of a lidar system currently operating only in the horizontal direction. This will allow measurements at an angle and in the vertical direction (up to 8-10 km) to study the stratification of aerosol layers in the atmosphere.

For this purpose, numerical modeling of the mirror was carried out using specialized software. Several variants were modeled using different materials and methods of deposition. All of them were adapted to the capabilities of the available technological system Symphony 9, Tecport Optics, USA. As a result, a variant of a 13-layer H(LH)<sup>6</sup> type coating with the materials SiO<sub>2</sub> (L layer) and TiO<sub>2</sub> (H layer) was selected.

The conformity of the spectral characteristic ( $R > 95\%$  at an angle of incidence 45 degrees for both wavelengths) of the manufactured mirror was checked by a Lambda 1050 (Perkin Elmer) precision research UV-Vis-NIR spectrophotometer. The reflectivity of the mirror was taken in absolute reflection mode at an incidence angle of 45 degrees. The strength and durability requirements were tested and verified on a specially made test specimen.

**Acknowledgements:** This work was supported by the Bulgarian Ministry of Education and Science, National Science Fund, grant No KP-06-N57/5 (2021).

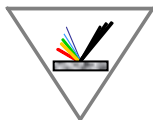

## P.F9

### ANALYZING PROTON TRANSFER RATE CONSTANTS IN TAUTOMERIC PROTON CRANES

Lidia Zaharieva<sup>1</sup>, Ivan Angelov<sup>1</sup> and Liudmil Antonov<sup>1</sup>

<sup>1</sup>*Institute of Electronics, Bulgarian Academy of Sciences, 1784 Sofia, Bulgaria*

*e-mail: [liudmil.antonov@gmail.com](mailto:liudmil.antonov@gmail.com)*

Tautomerism, a reversible isomerization phenomenon in the organic compounds, is essential in a wide range of chemical and biochemical processes. In this study, we investigate the switching for- and backward rate constants of two tautomeric cranes (Scheme 1), namely 8-(benzo[d]thiazol-2-yl)quinolin-7-ol (HQBT) and 8-(benzo[d]selenazol-2-yl)quinolin-7-ol (HQBSe), both based on 7-hydroxyquinoline (7OHQ). 7OHQ serves as an interesting example of long-range proton transfer (PT). It should be noted that, particularly in 7OHQ, the PT is intermolecular and solvent- or concentration-assisted [1]. Proton cranes are systems where the proton is transferred truly intramolecularly through structural modification [2].

Currently, based on the changes upon irradiation, we can determine that the tautomeric cranes HQBT and HQBSe switch to the on-state (keto tautomer). This is observed through measurements of their absorption spectra, as the absorption maximum shifts to 440 nm when the molecule switches to the on-state. The changes in the absorption maximum over time as a function of irradiation at 365 nm are used to monitor the forward (irradiation on) and backward (irradiation off) processes. Each of the studied compounds exhibits a different switching (from enol to keto) and relaxation times (from the keto to the enol form). By comparing these constants, we can ascertain which compound's keto form is more likely to be detected by using nuclear magnetic resonance (NMR). A longer relaxation time increases the likelihood of confirming the keto form with NMR. In this particular case, HQBSe, where backward relaxation occurs on a timescale of minutes due to the larger twisting barrier, gives a better opportunity to prove the structure of the keto tautomer by NMR.

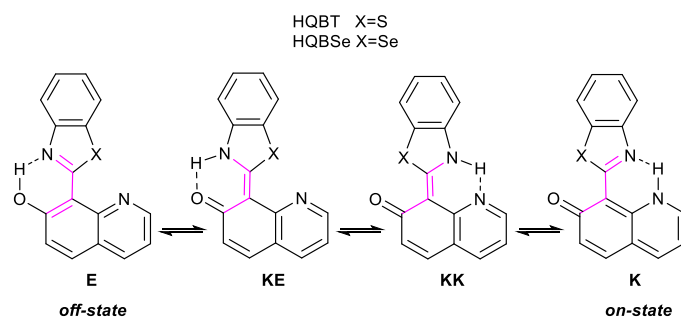

**Scheme 1.** PT in the studied compounds (HQBT and HQBSe).

#### References:

- [1] N. Al-Lawatia, J. Husband, T. Steinbrecher, O. K. Abou-Zied, “Tautomerism in 7-hydroxyquinoline: A combined experimental and theoretical study in water”, *The Journal of Physical Chemistry A*, 115(17), 4195-4201, (2011)
- [2] C. Rehagen, et al., “Reversible Switching Based on Truly Intramolecular Long-Range Proton Transfer—Turning the Theoretical Concept into Experimental Reality”, *Journal of the American Chemical Society*, 146(3), 2043-2053, (2024)



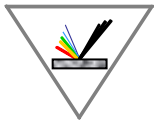

**Acknowledgements:** The authors thank the Bulgarian National Science Fund within National Science Program VIHREN by project T-Motors (contracted as KP-06-DV-9/2019) for the financial support for this investigation.

## P.F10

### STRUCTURE AND ELECTRICAL PROPERTIES OF TiO<sub>x</sub> FILMS DEPOSITED ON COOPER SUBSTRATES

D. Stoeva<sup>1</sup>, M. Ormanova<sup>1</sup>, G. Kotlarski<sup>1</sup>, D. Dechev<sup>1</sup>, N. Ivanov<sup>1</sup>, S. Valkov<sup>1,2</sup>, V. Mateev<sup>3</sup>,  
I. Marinova<sup>3</sup>

<sup>1</sup>*Institute of Electronics, Bulgarian Academy of Sciences, 72 Tsarigradsko Chaussee,  
1784 Sofia, Bulgaria*

<sup>2</sup>*Department of Mathematics, Informatics and Natural Sciences, Technical University of  
Gabrovo, 4 Hadzhi Dimitar Str., 5300 Gabrovo, Bulgaria*

<sup>3</sup>*Faculty of Electrical Engineering, Technical University of Sofia, 8 Kliment Ohridski Blvd.,  
1000 Sofia, Bulgaria*

*e-mail: [maria.ormanova87@gmail.com](mailto:maria.ormanova87@gmail.com)*

In the present work, the possibility was investigated of producing titanium oxide coatings using reactive magnetron sputtering on pure copper substrates. The structure of the copper substrate and the coatings were studied using X-ray diffraction (XRD). The influence of the coatings at every stage of development on the electrical properties of the overall samples was investigated. The conductivity of the samples as a function of the frequency of the power supply was presented and the results showed that improved electrical properties and stability were achieved through this method of surface modification. The further development of these types of coatings as protective electrically conductive films was also discussed.

**Acknowledgements:** The financial support of the Bulgarian National Scientific Fund, project # KP-06-N67/10 (2022) is greatly appreciated.

## P.F11

### INFLUENCE OF ELECTRON-BEAM SURFACE TREATMENT ON THE CRYSTALLOGRAPHY OF Co-Cr-Mo ALLOYS

F. Padikova<sup>1,2</sup>, G. Kotlarski<sup>2</sup>, B. Stoyanov<sup>2</sup>, I. Parhorov<sup>3</sup>, S. Parhorov<sup>3</sup>, M. Ormanova<sup>1</sup>,  
S. Valkov<sup>1,2</sup>

<sup>1</sup>*Institute of Electronics, Bulgarian Academy of Sciences, 72 Tsarigradsko Chaussee Blvd,  
1784 Sofia, Bulgaria*

<sup>2</sup>*Technical University of Garbovo, 4 H. Dimitar Str., 5300 Gabrovo, Bulgaria*

<sup>3</sup>*Institute of Metal Science, Equipment and Technologies with Hydro- and Aerodynamics  
Centre, Bulgarian Academy of Sciences, 67 Shipchenski Prohod Blvd, 1574 Sofia, Bulgaria*

*e-mail: [stsvalkov@gmail.com](mailto:stsvalkov@gmail.com)*

In this work, we present results on the influence of electron-beam surface treatment on the crystallographic structure of Co-Cr-Mo alloys. During the treatment procedure, the electron-beam power was 500 W and 750 W. The structure of the modified samples and of an untreated

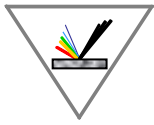

**XXIII International Conference and School on Quantum Electronics:  
“Laser Physics and Applications”**

one was studied by scanning electron microscopy and X-ray diffraction experiments. The results showed that applying the treatment procedure led to a transformation in the phase composition, from a double-phase structure of  $\epsilon$  and  $\gamma$  phases to a single-phase  $\gamma$  structure. Also, the results showed that in both cases the treatment procedure led to the formation of a preferred crystallographic orientation towards the (111) crystallographic plane. Applying the higher value of the electron-beam power resulted in the formation of a melted zone, while using the lower one did not produce such melting of the surface. The results obtained for the phase composition and preferred crystallographic orientation are discussed concerning the practical applications of the Co-Cr-Mo alloys.

**Acknowledgements:** This research was funded by the Bulgarian National Science Fund, grant number KP-06-N 67/7.

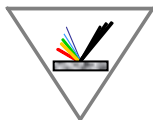

## P.F12

### INVESTIGATIONS ON THE INFLUENCE OF THE HEXAFERRITES SYNTHESIS ROUTE ON THEIR STRUCTURAL AND MAGNETIC PROPERTIES

B. Georgieva<sup>1</sup>, T. Koutzarova<sup>1</sup>, S. Kolev<sup>1,2</sup>, K. Krezhov<sup>1</sup>, Ch. Ghelev<sup>1</sup>, D. Kovacheva<sup>3</sup>, P. Tzvetkov<sup>3</sup>, L.-M. Tran<sup>4</sup>, M. Babij<sup>4</sup>, B. Vertruyen<sup>5</sup>, R. Closset<sup>5</sup>

<sup>1</sup>*Institute of Electronics, Bulgarian Academy of Sciences, 72 Tsarigradsko Chaussee, 1784 Sofia, Bulgaria*

<sup>2</sup>*Neofit Rilski South-Western University, 66 Ivan Mihailov Str., 2700 Blagoevgrad, Bulgaria*

<sup>3</sup>*Institute of General and Inorganic Chemistry, Bulgarian Academy of Sciences, Acad. Georgi Bonchev Str., bld. 11, 1113 Sofia, Bulgaria*

<sup>4</sup>*Institute of Low Temperature and Structure Research, Polish Academy of Sciences, ul. Okólna 2, 50-422 Wrocław, Poland*

<sup>5</sup>*Greenmat, Chemistry Department, University of Liege, 11 allée du 6 août, 4000 Liège, Belgium*

*e-mail: [b.georgiewa@abv.bg](mailto:b.georgiewa@abv.bg)*

With the rapid development of nanotechnology, various methods of obtaining novel oxide materials have been devised and/or improved. The practical experience thus accumulated allowed, in particular, the development of various techniques for the synthesis of complex functional oxides with a highly complicated crystal structure consisting of multiple sublattices, such as the magnetic oxides with hexagonal structure. The latter are an important class of magnetic materials with intricate and promising multiferroic properties, as exemplified by the M (BaFe<sub>12</sub>O<sub>19</sub>) and Y (Ba(Sr)<sub>2</sub>Me<sub>2</sub>Fe<sub>12</sub>O<sub>22</sub>) type hexaferrites.

In this work, we present a comparative analysis of the influence of the preparation method on the phase composition, morphology and magnetic behavior of Al-substituted BaFe<sub>12</sub>O<sub>19</sub> and Ba<sub>0.5</sub>Sr<sub>1.5</sub>Zn<sub>2</sub>Fe<sub>11.92</sub>Al<sub>0.08</sub>O<sub>22</sub> hexaferrites synthesized by sol-gel auto-combustion and ultrasonic co-precipitation.

Depending on the soft chemistry method, BaFe<sub>12-x</sub>Al<sub>x</sub>O<sub>19</sub> powder samples were synthesized with particle sizes between 70 nm and 200 nm. The average particle size of the powder obtained via the sonochemical method was 160 nm, whereas the auto-combusted powder exhibited an average size of 92 nm. The powders prepared sonochemically displayed a well-developed hexagonal shape, while the particles smaller than 110 nm lacked a fully formed hexagonal shape. Both types of particles tended to agglomerate due to the strong magnetic forces and the high surface energy of the nanoparticles. At an applied field of 50 kOe, the saturation magnetization ( $M_s$ ) and remanent magnetization ( $M_R$ ) were higher for samples prepared through ultrasonic co-precipitation compared to those obtained by the auto-combustion method, at both used temperatures (4.2 K and 300 K).

During the synthesis of Al-substituted Ba<sub>0.5</sub>Sr<sub>1.5</sub>Zn<sub>2</sub>Fe<sub>12</sub>O<sub>22</sub> powders via the sol-gel auto-combustion method, a melting process was observed in the substituted Ba<sub>0.5</sub>Sr<sub>1.5</sub>Zn<sub>2</sub>Al<sub>0.08</sub>Fe<sub>11.92</sub>O<sub>22</sub> hexaferrite, leading to the formation of particles with a hexagonal shape. Conversely, the Ba<sub>0.5</sub>Sr<sub>1.5</sub>Zn<sub>2</sub>Al<sub>0.08</sub>Fe<sub>11.92</sub>O<sub>22</sub> powder synthesized through ultrasonic co-precipitation consisted both of particles of various size and shape and of particles with a fully developed hexagonal structure. Notably, the Sr<sub>1.5</sub>Ba<sub>0.5</sub>Zn<sub>2</sub>Fe<sub>11.92</sub>Al<sub>0.08</sub>O<sub>22</sub> samples prepared by ultrasonic co-precipitation displayed a triple hysteresis curve at room temperature. This observation of a triple hysteresis loop in low magnetic fields ranging from 1 to -1 kOe indicates

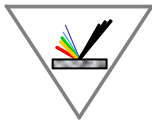

the presence of two kinds of ferrimagnetic phases with differing magnetization values within the field range of 50 to  $-50$  kOe.

**Acknowledgements:** Borislava Georgieva was supported by the Bulgarian Ministry of Education and Science under the National Research Programme “Young scientists and postdoctoral students-2” approved by DCM 206/07.04.2022. The work was supported by the Bulgarian National Science Fund under contract KP-06-N48/5 "Multifunctional composite structures based on ferrites (including magneto-electrics) and carbon materials". This work was also supported by a joint research project between the Bulgarian Academy of Sciences and WBI, Belgium, and by a joint research project between the Bulgarian Academy of Sciences and the Institute of Low Temperature and Structure Research, Polish Academy of Sciences.

## P.F13

### DEVELOPMENT OF A WHITE-LIGHT GENERATOR FOR TRANSIENT ABSORPTION SPECTROSCOPY USING DIELECTRIC MULTILAYER COATINGS FOR SPECTRAL SMOOTHING

E. Stoyanova<sup>1,\*</sup>, L. Petrov<sup>2</sup>, A. Tenev<sup>1</sup>, I. Miloushev<sup>1</sup>, T. Tenev<sup>1</sup>, D. Velkov<sup>2</sup>, A. Trifonov<sup>2</sup> and I. Buchvarov<sup>2,\*</sup>

<sup>1</sup>*Institute of Electronics, Bulgarian Academy of Sciences, 72 Tsarigradsko Chaussee Blvd., 1784 Sofia, Bulgaria*

<sup>2</sup>*Sofia University St. Kliment Ohridski, 15 Tsar Osvoboditel Blvd., 1504 Sofia, Bulgaria*

*e-mail: [e.stoyanova@issp.bas.bg](mailto:e.stoyanova@issp.bas.bg), [\\*ivan.buchvarov@phys.uni-sofia.bg](mailto:ivan.buchvarov@phys.uni-sofia.bg)*

The development of the pump-probe spectroscopic technique, or transient absorption (TA), has greatly advanced our understanding of the ultrafast processes in matter. We utilize it to measure the excited state absorption with a time resolution establishing the dynamics (lifetimes) of the excited state energy levels of the electronic quantum system. The modern fs-TA spectroscopy technique currently uses a delayed femtosecond white-light continuum (WLC) as a broad-band probe instead of a tunable single wavelength probe [1]. The TA spectrometer measures the change in sample absorption as a function of the wavelength and time. The spectral window in which the energy levels can be studied is very important in obtaining complete information about the quantum system. This window is defined by the bandwidth of the WLC used to probe the system and the dynamic range of the detector. The WLC is relatively easily obtained from fs pulses in CaF<sub>2</sub> or sapphire plates, but its characteristic spectrum makes it unusable directly because the amplitudes of the spectrum around the wavelength of the seed to the broad blue wing are related to each other by orders of magnitude ( $10^{3-5}$ ) [2], and without specific spectral filtering both spectral regions cannot easily fall into the dynamic range of the detector. On the other hand, the major part of the WLC pulse energy is located specifically around the seed wavelength (typically a few microjoules), and when we focus it into the sample, it is likely to induce nonlinear processes into the optical material of the sample; hence, it introduces significant distortions or artifacts into the transient signal.

Due to the low efficiency when generating WLC, a notch filter is crucial in suppressing the intensity at the initial seed wavelength, allowing for most of the WLC after the filter to fall within the dynamic range of the detector. Here we report advanced multilayer coatings used for spectra smoothing. It was calculated and realized thanks to the exact determination of the

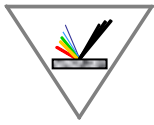

optical constants of the substances in the notch filter by reverse engineering of spectrophotometric measurements.

**References:**

[1] M. Raytchev, E. Pandurski, I. Buchvarov, C. Modrakowski, T. Fiebig, “Bichromophoric Interactions and Time-Dependent Excited State Mixing in Pyrene Derivatives. A Femtosecond Broad-Band Pump–Probe Study”, *J. Phys. Chem. A*, 107, 4592-4600, (2003)

[2] I. Buchvarov, A. Trifonov, T. Fiebig, “Toward an understanding of white-light generation in cubic media—polarization properties across the entire spectral range”, *Opt. Lett.*, 32, 1539-1541, (2007)

[3] E. N. Kotlikov, N. P. Lavrovskaya, T. K. Tenev, I. K. Milushev, “Aluminum oxide (Al<sub>2</sub>O<sub>3</sub>) optical films and their applications in the ultraviolet region of the spectrum”, *Journal of Optical Technology*, 89, 752-756, (2022)

**Acknowledgements:** We acknowledge funding from the National Science Fund of Bulgaria (KP-06-N58/6/2021 and KP-06-N57/5/2021).

## P.F14

### ELASTOMERIC COMPOSITES FOR APPLICATION AS PRESSURE SENSORS

Petrunka Malinova<sup>1</sup>, Dimitar Dimov<sup>2</sup>, Kamen Ivanov<sup>2</sup>, Stefan Kolev<sup>2</sup>, Dobromir Kalchevski<sup>2</sup>,  
Aneliya Kostadinova<sup>3</sup>, Teodor Milenov<sup>2</sup>

<sup>1</sup>*University of Chemical Technology and Metallurgy, 8 Kl. Ohridski Blvd.,  
1756 Sofia Bulgaria*

<sup>2</sup>*Institute of Electronics, Bulgarian Academy of Sciences, 72 Tsarigradsko Chaussee,  
1784 Sofia, Bulgaria*

<sup>3</sup>*Institute of Biophysics and Biomedical Engineering, Bulgarian Academy of Sciences,  
Acad. Georgi Bonchev Str., Bl. 105, 1113 Sofia Bulgaria*

*e-mail: [dobromirak@ie.bas.bg](mailto:dobromirak@ie.bas.bg)*

The elastomers are usually considered as being insulators, but the addition of conductive fillers improves the conductivity of the bulk material. One of the applications of conductive elastomeric composites is as pressure sensors. Their main advantages over other materials used as pressure sensors are flexibility, high elasticity, the ability to absorb mechanical shocks, as well as low cost.

The present work reports on preparing elastomeric composites containing modified carbon blacks and studying the changes in their bulk electrical resistance depending on the external pressure applied (from 0 to 45 kPa). For this purpose, elastomeric composites based on butadiene acrylonitrile rubber (NBR) were prepared, containing a filler in a wide concentration range from 10 to 80 phr (parts per 100 parts of rubber) The specific surface area (BET), textural characteristics, and the oil number of the filler, as well as important physicochemical and electrical parameters of the obtained composites, were determined. The percolation threshold was identified, and the potential use of the composite materials as pressure sensors was evaluated based on the relationship between volume electrical resistivity and the external pressure applied.

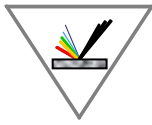

## P.F15

### STUDY OF THE LINE GRATING PROFILES IN PMMA BILAYER ON SiO<sub>2</sub>/Si SUBSTRATE AT 20 KEV ELECTRON ENERGY

Robert Andok<sup>1</sup>, Katia Vutova<sup>2,b</sup>, Elena Koleva<sup>2</sup>, Anna Bencurova<sup>1</sup>, Mario Ritomsky<sup>1</sup> and  
Ivan Kostic<sup>1,a</sup>

<sup>1</sup>*Institute of Informatics, Slovak Academy of Sciences, Dubravska cesta 9, 845 07 Bratislava, Slovak Republic*

<sup>2</sup>*Institute of Electronics, Bulgarian Academy of Sciences, 72 Tsarigradsko Chaussee Blvd, 1784 Sofia, Bulgaria*

*e-mail: <sup>a</sup>[ivan.kostic@savba.sk](mailto:ivan.kostic@savba.sk), <sup>b</sup>[katia@van-computers.com](mailto:katia@van-computers.com)*

This article presents experiments and simulation of the electron lithography process with the aim of finding optimal parameters for lift-off technique, which is a crucial step in the process of creating metal patterns on a substrate utilizing an electron beam.

The resist sidewall shape depends on several parameters: beam energy and current, exposure dose, beam size and shape, substrate properties, chemical composition of the resist, development process conditions, and proximity effects. Achieving high-quality patterns with precisely defined sidewalls requires experimentation, simulation, and process optimization.

Direct writing electron beam lithography was used in the experiments. The exposure was performed using a ZBA21 electron beam lithography system (Vistec electron beam GmbH, Jena, Germany). A bilayer was studied comprising two PMMA resists with different molecular weights – 950 000 on the top and 495 000 on the bottom (different sensitivities accordingly). The shape of the developed resist images obtained in the case of a line grating (L/S 100/500 nm) was studied and the influence of the exposure dose on the sidewall geometry of the developed profiles in a 550-nm bilayer PMMA resist system was investigated experimentally and theoretically in order to achieve close-to-vertical profile sidewalls.

Contour plots will be obtained by simulation of the developed bilayer PMMA resist half linewidths depending on the exposure dose along the resist depth, which will allow the profile geometry to be predicted.

Figure 1 shows selected images with a typical sidewall shape in the case of line grating with a pitch of 600 nm in a 550 nm thin bilayer of PMMA A2/PMMA A6 (Kayaku) at exposure doses of 520  $\mu\text{C}/\text{cm}^2$  (Fig. 1 a), and 840  $\mu\text{C}/\text{cm}^2$  (Fig. 1 b).

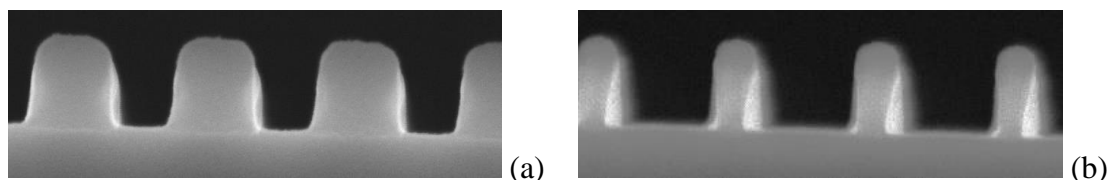

**Figure 1.** Selected images with a typical sidewall shape in the case of line grating with a pitch of 600 nm in a 550 nm thin bilayer of PMMA A2/PMMA A6 at exposure doses of (a) 520  $\mu\text{C}/\text{cm}^2$ , (b) 840  $\mu\text{C}/\text{cm}^2$ .

**Acknowledgements:** This work was supported by the Bulgarian Academy of Sciences within the SAS-BAS joint research project IC-SK/01/2023-2024, by the Slovak Academy of Sciences within the joint research project SAS-BAS-2022-05, and by the Ministry of Education of the Slovak Republic and the Slovak Academy of Sciences under the contract VEGA 2/0099/22.

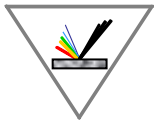

## P.F16

### STRUCTURAL AND MAGNETIC CHARACTERIZATION OF NANOSTRUCTURED ZnFe<sub>2</sub>O<sub>4</sub> SYNTHESIZED BY SONOCHEMISTRY

K. Krezhov<sup>1</sup>, L.-M. Tran<sup>2</sup>, M. Babij<sup>2</sup>, B. Georgieva<sup>1</sup>, T. Malakova<sup>1</sup>, S. Kolev<sup>1,3</sup>,  
T. Koutzarova<sup>1</sup>

<sup>1</sup>*Institute of Electronics, Bulgarian Academy of Sciences, 72 Tsarigradsko Chaussee,  
1784 Sofia, Bulgaria*

<sup>2</sup>*Institute of Low Temperature and Structure Research, Polish Academy of Sciences,  
ul. Okólna 2, 50-422 Wrocław, Poland*

<sup>3</sup>*Neofit Rilski South-Western University, 66 Ivan Mihailov Str., 2700 Blagoevgrad, Bulgaria*

*e-mail: [kiril.krezhov@gmail.com](mailto:kiril.krezhov@gmail.com)*

Zinc ferrite (ZnFe<sub>2</sub>O<sub>4</sub>) has long been of interest not only in fundamental research because of its intrinsic intriguing magnetic behavior. The spinel's multi-degree-of-freedom tunable structure of its complex cubic symmetry provides a great potential in technological applications, as energy conversion and storage materials, catalysts, ferrofluids, etc. Added to the well-adapted magnetic properties, the excellent biocompatibility and minimal toxicity contribute to the capabilities of zinc ferrite-based nanomaterials in cancer theranostics, particularly for magnetic hyperthermia applications. Here, we present the structural and magnetic properties of nanosized ZnFe<sub>2</sub>O<sub>4</sub> powders synthesized by sonochemistry and discuss their dependence on the synthesis conditions. The ultrasonic chemical co-precipitation approach has a number of attractive features, including fast reaction time, good product purity, small particle size, low cost, and efficiency and environmental friendliness. The powder products were synthesized by optimizing the ultrasonic power (up to 750 W) and their properties were investigated by X-ray diffraction (XRD), scanning and transmission electron microscopy (SEM, TEM), SQUID magnetometry. The XRD findings of the as-prepared material revealed crystalline ZnFe<sub>2</sub>O<sub>4</sub> and an amorphous phase fraction. After annealing at 500°C the peaks became markedly narrower, proving a high degree of crystallinity, and the indexing showed full compatibility with the single-phase spinel-type structure (space group Fd-3m, No 227). The as-prepared and annealed samples exhibited paramagnetic behavior above approximately 125 K. A very narrow hysteresis curve was recorded at 4.2 K as a signature of ferrimagnetic behavior of the particles at such low temperatures. This finding is along the line of suggestion that the cation distributions in such nanostructured spinel materials are partially inverted, widening the scope of new technically and economically important applications materials.

**Acknowledgements:** The work was supported by the Bulgarian National Science Fund under contract KP-06-N48/5 “Multifunctional composite structures based on ferrites (including multiferroics) and carbon materials”, and by a research project between the Institute of Electronics, BAS and Institute of Low Temperature and Structure Research, PAN.

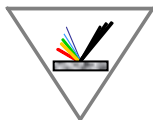

## P.F17

### Z-TYPE HEXAFERRITE: PREPARATION AND PROPERTIES

T. Malakova<sup>1</sup>, K. Krezhov<sup>1</sup>, S. Kolev<sup>1,2</sup>, P. Peneva<sup>1</sup>, Ch. Ghelev<sup>1</sup>, B. Vertruyen<sup>3</sup>, R. Closset<sup>3</sup>,  
L.-M. Tran<sup>4</sup>, M. Babij<sup>4</sup>, P. Tzvetkov<sup>5</sup>, D. Kovacheva<sup>5</sup>, T. Koutzarova<sup>1</sup>

<sup>1</sup>*Institute of Electronics, Bulgarian Academy of Sciences, 72 Tsarigradsko Chaussee,  
1784 Sofia, Bulgaria*

<sup>2</sup>*Neofit Rilski South-Western University, 66 Ivan Mihailov Str., 2700 Blagoevgrad, Bulgaria*

<sup>3</sup>*Greenmat, Chemistry Department, University of Liege, 11 allée du 6 août,  
4000 Liège, Belgium*

<sup>4</sup>*Institute of Low Temperature and Structure Research, Polish Academy of Sciences,  
ul. Okólna 2, 50-422 Wrocław, Poland*

<sup>5</sup>*Institute of General and Inorganic Chemistry, Bulgarian Academy of Sciences,  
1113 Sofia, Bulgaria*

e-mail: [tanya\\_malakova@abv.bg](mailto:tanya_malakova@abv.bg)

The interest in magneto-electric multiferroic materials in which ferroelectricity and ferromagnetism are both present is due to the magneto-electric effect. The main requirement to the applications of the magneto-electric multiferroic materials is that the magneto-electric coupling be both large and active at room temperature and the magnetic ordering temperature be high. The Z-type hexaferrite  $\text{Sr}_3\text{Co}_2\text{Fe}_{24}\text{O}_{41}$  exhibits a magneto-electric effect at room temperature. We report studies on the structural and magnetic properties of  $\text{Sr}_3\text{Co}_2\text{Fe}_{24}\text{O}_{41}$  in powders and in bulk form. The precursor powders were prepared following the sol-gel auto-combustion method and synthesized at 1200-1250°C to produce  $\text{Sr}_3\text{Co}_2\text{Fe}_{24}\text{O}_{41}$  and rapidly quenched to room temperature. The XRD spectra of the powder showed the characteristic peaks corresponding to the Z-type hexaferrite structure as a main phase. The various phases that emerge during the synthesis process of  $\text{Sr}_3\text{Co}_2\text{Fe}_{24}\text{O}_{41}$ , along with the corresponding microstructures, were thoroughly presented. The SEM images of the powder sample showed that the particles were well agglomerated to form clusters of different sizes and shapes. In the bulk sample, we clearly observed large regions of the hexagonal particles with a structure ordered along the *c* axis. The EDX analysis of these areas indicated that the pellets were composed of Sr:Co:Fe at a ratio close to the stoichiometric one in  $\text{Sr}_3\text{Co}_2\text{Fe}_{24}\text{O}_{41}$ . The analysis of the separate chemical elements' in-depth distribution revealed a homogeneous distribution of Sr, Co, Fe and O atoms. Magnetic phase transitions in the temperature range of 4.2 – 300 K were also observed connected to the different spin structure. The results of the ZFC and FC magnetization measurements showed the change in the magnetization behavior at 300 K, which is related to the magnetic phase transition from ferrimagnetic to transverse conical spin order. Therefore, the magneto-electric effect can be observed below 300 K.

**Acknowledgements:** The work was supported by the Bulgarian National Science Fund under contract KP-06-N48/5, by a joint research project between the Bulgarian Academy of Sciences and the Institute of Low Temperature and Structure Research, Polish Academy of Sciences and by a joint research project between the Bulgarian Academy of Sciences and WBI, Belgium.



# We would like to thank



БЪЛГАРСКА АКАДЕМИЯ НА НАУКИТЕ ИНСТИТУТ ЕЛЕКТРОНИКА "АКАДЕМИК ЕМИЛ ДИЯКОВ"  
BULGARIAN ACADEMY OF SCIENCES INSTITUTE OF ELECTRONICS "ACADEMICIAN EMIL DIJKOV"



NATIONAL  
SCIENCE  
FUND - BULGARIA

Project КП-06-МНФ/3 от 23.05.2024

BNSF may not be held liable for the content of the reports and published materials of the scientific forum

БЪЛГАРСКА  
АКАДЕМИЯ  
НА НАУКИТЕ

155

BULGARIAN  
ACADEMY  
OF SCIENCES



25 АКВАХИМ  
AQUACHIM

ГОДИНИ

OPTICA  
Formerly OSA



ВАЛЕРУС®

ASTEL